

Shinye®

PRODUCT
CATALOG

PRODUCT CATALOG



www.shinye-ortho.com 

Shinye®

Zhejiang Shinye Medical Technology Corp., Ltd

Add: No. 1032 Tongyi Road, Gongshu District, Hangzhou, 310015, China

Tel: 86-571-58102870

Fax: 86-571-58102890

Email: export@shinye-ortho.com

Zhejiang Shinye Medical Technology Corp., Ltd





OVER 20 YEARS

About shinye

Since its inception in 1994, Shinye Orthodontic Products Co.,Ltd. has become one of the leading companies which research, develop, manufacture and sell orthodontic products in China. We are dedicated to cooperating and communicating with famous professors and clinicians from universities and hospitals nationwide. Shinye has won a good reputation in orthodontic domain for its high quality products.

Shinye is now an ISO 9001, ISO 13485 and FDA registered company selling in over countries around the world .

The detailed development of Shinye:

- ◆ In 1999, Shinye firstly developed and manufactured the advanced series of Mesh Brackets and Buccal Tubes in China, and pushed them into market successfully.
- ◆ In 2000, Shinye firstly applied MIM Technology to the production of orthodontic appliances in China.
- ◆ In 2005, Shinye developed a new series of Mesh Brackets and Buccal Tubes.
- ◆ In 2007, Shinye developed the traditional series of Transmission Roth Brackets and Class III series of Brackets with double slots and cross tubes base easy for three dimensional treatment.
- ◆ In 2011, Shinye was evaluated by the National Technical Committee on professional standardization as a member of the National Commission on oral materials and equipment.
- ◆ In 2012, Shinye won the two prize in Chinese medical science and technology ,issued by the Chinese Medical Association.
- ◆ In 2012, Shinye developed the Physiological Anchorage Spee's-wire (PASS)
- ◆ In 2015, Shinye developed the Nickel Titanium Archwires and Ceramic Brackets.
- ◆ In 2016, Shinye was appraised as a National high-tech enterprise.
- ◆ In 2017, Shinye was appraised by the National oral materials and Equipment Standardization Technical Committee as the standard advanced unit.

The quality guideline of Shinye is :People-oriented, Good quality, Honesty and reliability, keeping improving. Shinye is continuously offering the high quality, innovative products and excellent customer service to every clinician and patient. Shinye is dedicated to becoming a company that customers trust and thus making contributions to the worldwide orthodontic development.



Smile together with a sincere heart.

Table of Contents

- 01** Self-Ligating Brackets
- 02** Ceramic Brackets
- 03** Lingual Brackets
- 04** Metal Brackets
- 05** Buccal Tubes
- 06** Bands
- 07** Archwires
- 08** Accessories
- 09** Elastomers
- 10** Instruments

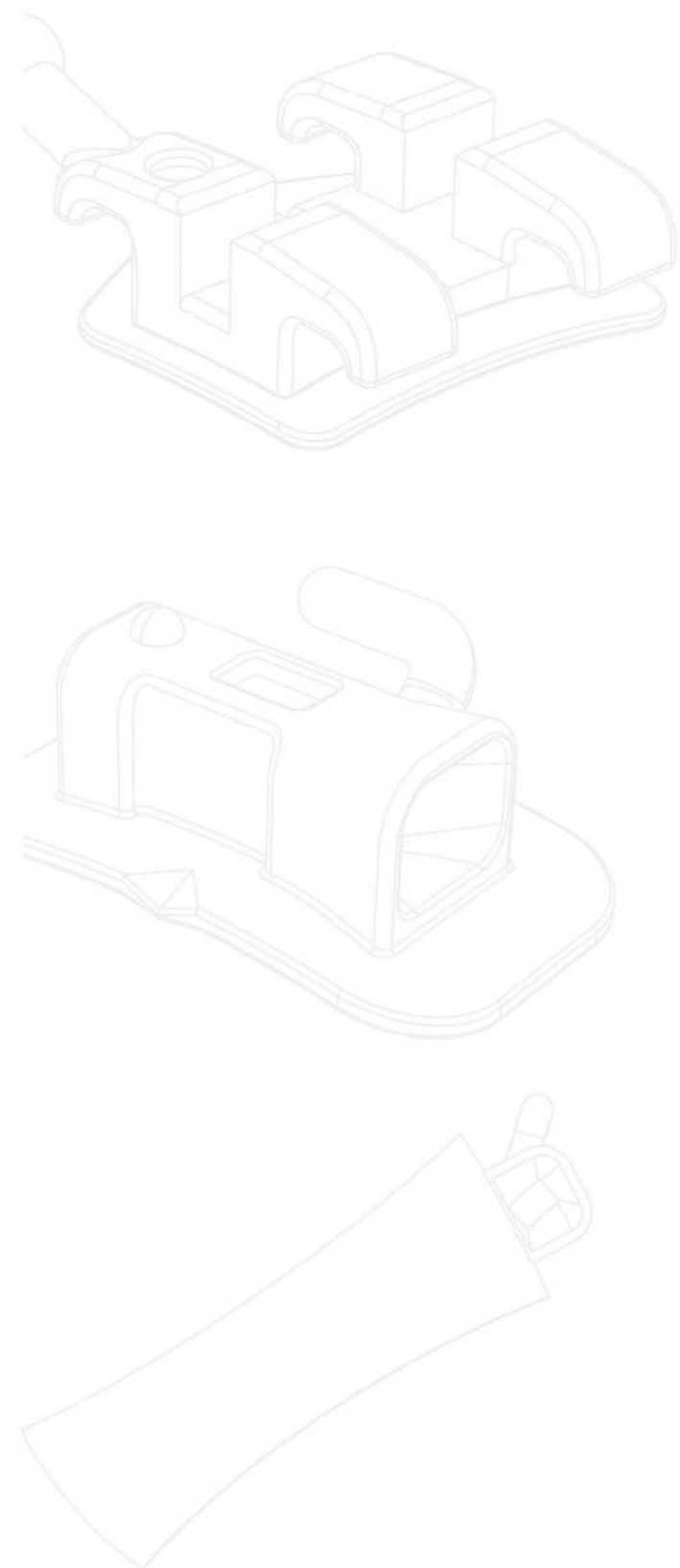

FDI System

17	16	15	14	13	12	11	21	22	23	24	25	26	27
7	6	5	4	3	2	1	1	2	3	4	5	6	7
7	6	5	4	3	2	1	1	2	3	4	5	6	7
47	46	45	44	43	42	41	31	32	33	34	35	36	37

A7	A6	A5	A4	A3	A2	A1	B1	B2	B3	B4	B5	B6	B7
7	6	5	4	3	2	1	1	2	3	4	5	6	7
7	6	5	4	3	2	1	1	2	3	4	5	6	7
C7	C6	C5	C4	C3	C2	C1	D1	D2	D3	D4	D5	D6	D7

Color/Hook Designation

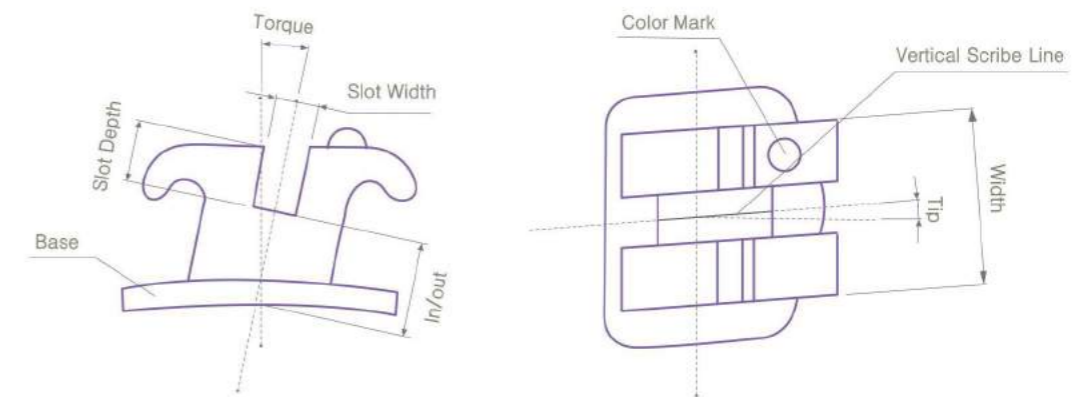
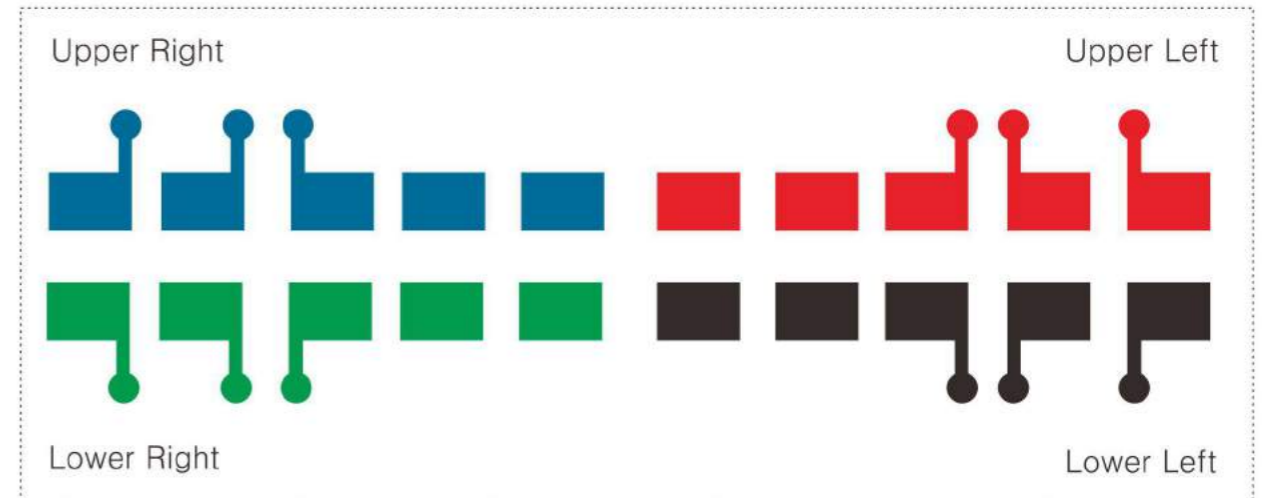

The SHINYE's versions of MBT* do not indicate any endorsement by Drs. Mclaughlin, Bennett, or Trevisi.

SELF-LIGATING BRACKETS

Self-Ligating Brackets

Flex-M1 Series	1.03
Flex-M3 Series	1.05
Flex-M5 Series	1.07
Flex-C Series	1.09



Self-Ligating Brackets

FLEX-M1 Series

ROTH

	Tooth	Torq.	Ang.	M/D Width	Hook	L/R	.018 Slot		.022 Slot	
							Part No.	Part No.	Part No.	Part No.
Maxillary	Central	12°	5°	3.2	—	UR1	82M3-10I-11	82M3-20I-11		
						UL1	82M3-10I-21	82M3-20I-21		
	Lateral	8°	9°	2.7	—	UR2	82M3-10I-12	82M3-20I-12		
						UL2	82M3-10I-22	82M3-20I-22		
	Cuspid	-2°	11°	3.0	—	UR3	82M3-10I-13	82M3-20I-13		
							W	82M3-11I-13	82M3-21I-13	
						UL3	82M3-10I-23	82M3-20I-23		
							W	82M3-11I-23	82M3-21I-23	
	1st & 2nd Bicuspid	-7°	0°	2.9	—	UR4/5	82M3-10I-14	82M3-20I-14		
							W	82M3-11I-14	82M3-21I-14	
						UL4/5	82M3-10I-24	82M3-20I-24		
							W	82M3-11I-24	82M3-21I-24	
Mandibular	Anteriors	-1°	0°	2.7	—	L12	82M3-10I-31	82M3-20I-31		
	Cuspid	-11°	5°	2.9	—	LL3	82M3-10I-33	82M3-20I-33		
							W	82M3-11I-33	82M3-21I-33	
					LR3	82M3-10I-43	82M3-20I-43			
						W	82M3-11I-43	82M3-21I-43		
	1st Bicuspid	-17°	0°	2.9	—	LL4	82M3-10I-34	82M3-20I-34		
							W	82M3-11I-34	82M3-21I-34	
					LR4	82M3-10I-44	82M3-20I-44			
						W	82M3-11I-44	82M3-21I-44		
	2nd Bicuspid	-22°	0°	2.9	—	LL5	82M3-10I-35	82M3-20I-35		
							W	82M3-11I-35	82M3-21I-35	
					LR5	82M3-10I-45	82M3-20I-45			
						W	82M3-11I-45	82M3-21I-45		

Bracket Kits	0.018		0.022	
	Part No.	Part No.	Part No.	Part No.
Upper/Lower 5x5 No Hook	82M3-10I		82M3-20I	
Upper/Lower 5x5 Hook on 3	82M3-13I		82M3-23I	
Upper/Lower 5x5 Hook on 3,4,& 5	82M3-15I		82M3-25I	

FLEX-M1 Series

MBT*

	Tooth	Torq.	Ang.	M/D Width	Hook	L/R	.018 Slot		.022 Slot	
							Part No.	Part No.	Part No.	Part No.
Maxillary	Central	17°	4°	3.2	—	UR1	83M3-10I-11	83M3-20I-11		
						UL1	83M3-10I-21	83M3-20I-21		
	Lateral	10°	8°	2.7	—	UR2	83M3-10I-12	83M3-20I-12		
						UL2	83M3-10I-22	83M3-20I-22		
	Cuspid	-7°	8°	3.0	—	UR3	83M3-10I-13	83M3-20I-13		
							W	83M3-11I-13	83M3-21I-13	
						UL3	83M3-10I-23	83M3-20I-23		
							W	83M3-11I-23	83M3-21I-23	
	1st & 2nd Bicuspid	-7°	0°	2.9	—	UR4/5	83M3-10I-14	83M3-20I-14		
							W	83M3-11I-14	83M3-21I-14	
						UL4/5	83M3-10I-24	83M3-20I-24		
							W	83M3-11I-24	83M3-21I-24	
Mandibular	Anteriors	-6°	0°	2.7	—	L12	83M3-10I-31	83M3-20I-31		
	Cuspid	-6°	3°	2.9	—	LL3	83M3-10I-33	83M3-20I-33		
							W	83M3-11I-33	83M3-21I-33	
					LR3	83M3-10I-43	83M3-20I-43			
						W	83M3-11I-43	83M3-21I-43		
	1st Bicuspid	-12°	2°	2.9	—	LL4	83M3-10I-34	83M3-20I-34		
							W	83M3-11I-34	83M3-21I-34	
					LR5	83M3-10I-44	83M3-20I-44			
						W	83M3-11I-44	83M3-21I-44		
	2nd Bicuspid	-17°	2°	2.9	—	LL5	83M3-10I-35	83M3-20I-35		
							W	83M3-11I-35	83M3-21I-35	
					LR5	83M3-10I-45	83M3-20I-45			
						W	83M3-11I-45	83M3-21I-45		

Bracket Kits	0.018		0.022	
	Part No.	Part No.	Part No.	Part No.
Upper/Lower 5x5 No Hook	83M3-10I		83M3-20I	
Upper/Lower 5x5 Hook on 3	83M3-13I		83M3-23I	
Upper/Lower 5x5 Hook on 3,4,& 5	83M3-15I		83M3-25I	



FLEX M1 Series

- Use special opening tool or opening dental probe, simple and convenient;
- Clip can be directly closed with a finger, easy for operation;
- Reliable structural design to avoid clip deformation and falling problems;
- High flexible material ensure clip still maintain the original effect after open and close a hundred times

FLEX-M3 Series

ROTH

	Tooth	Torq.	Ang.	M/D Width	Hook	L/R	.022 Slot
	Maxillary	Central	12°	5°	3.4	—	UR1
UL1							82K6-20K-21
Lateral		8°	9°	2.8	—	UR2	82K6-20K-12
						UL2	82K6-20K-22
Cuspid		-2°	11°	3.4	—	UR3	82K6-20K-13
					W		82K6-21K-13
					—	UL3	82K6-20K-23
		W	82K6-21K-23				
1st & 2nd Bicuspid		-7°	0°	3.4	—	UR4/5	82K6-20K-14
					W		82K6-21K-14
	—				UL4/5	82K6-20K-24	
	W	82K6-21K-24					
Mandibular	Anteriors	0°	0°	2.5	—	L12	82K6-20K-31
	Cuspid	-11°	5°	3.0	—	LL3	82K6-20K-33
					W		82K6-21K-33
					—	LR3	82K6-20K-43
	W	82K6-21K-43					
	1st Bicuspid	-17°	0°	3.0	—	LL4	82K6-20K-34
					W		82K6-21K-34
					—	LR4	82K6-20K-44
	W	82K6-21K-44					
	2nd Bicuspid	-22°	0°	3.0	—	LL5	82K6-20K-35
					W		82K6-21K-35
					—	LR5	82K6-20K-45
W	82K6-21K-45						
Bracket Kits							0.022
	Upper/Low er 5x5 No Hook						82K6-20K
	Upper/Low er 5x5 Hook on 3						82K6-23K
	Upper/Low er 5x5 Hook on 3,4,& 5						82K6-25K

FLEX-M3 Series

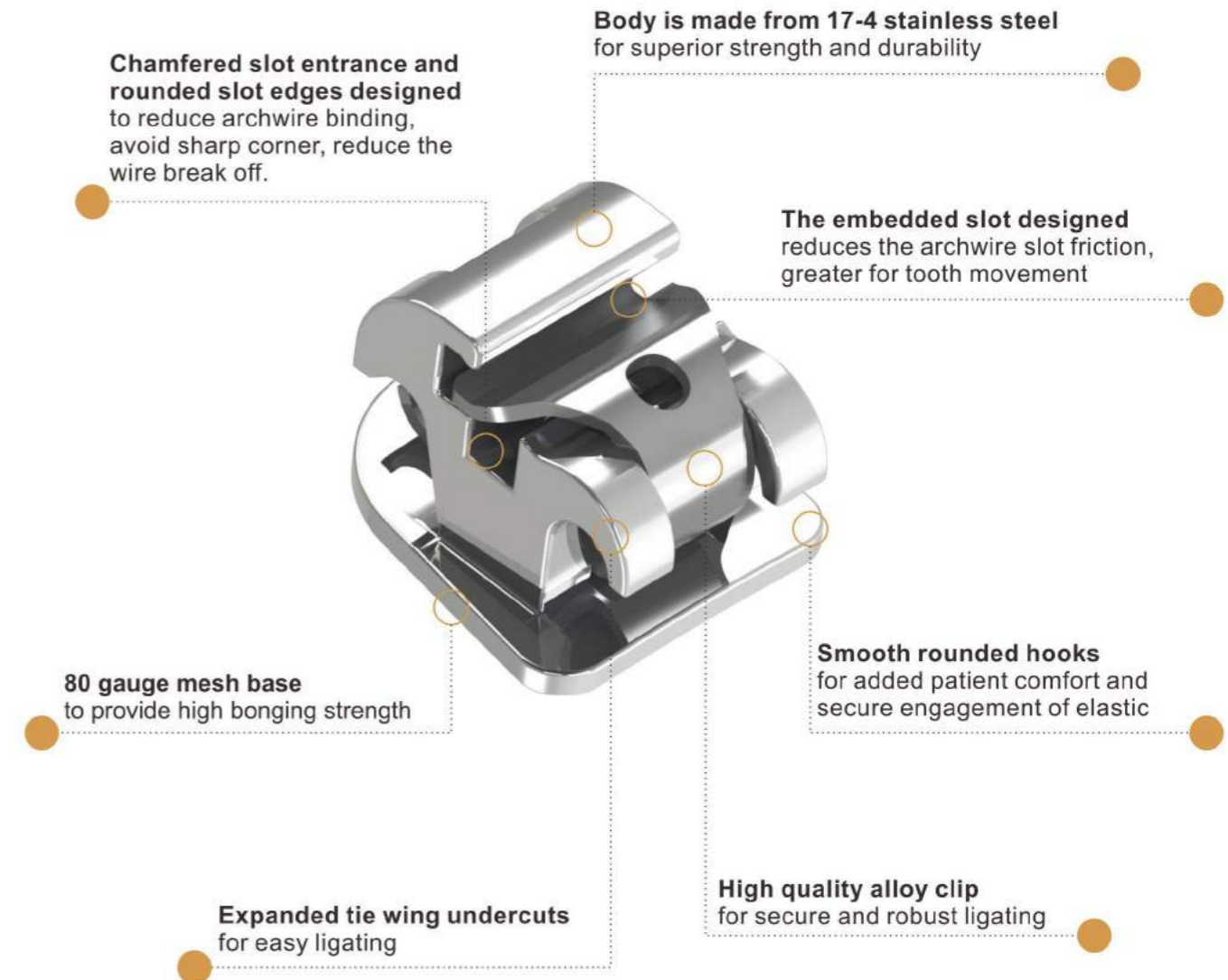

- Self-Ligating Brackets
- Ceramic Brackets
- Lingual Brackets
- Metal Brackets
- Buccal tubes
- Bands
- Archwires
- Accessories
- Elastomerics
- Instruments

M3

FLEX-M5 Series

ROTH

	Tooth	Torq.	Ang.	M/D Width	Hook	L/R	.022 Slot
	Maxillary	Central	12°	5°	2.8	—	UR1
UL1							82FA-20H-21
Lateral		8°	10°	2.8	—	UR2	82FA-20H-12
						UL2	82FA-20H-22
Cuspid		-2°	10°	2.8	—	UR3	-
						W	82FA-21H-13
	—					-	
1st & 2nd Bicuspid	-7°	0°	2.8	—	UR45	82FA-20H-14	
					W	82FA-21H-14	
					—	82FA-20H-24	
					UL45	82FA-21H-24	
					W		
					—		
Mandibular	Anteriors	-1°	0°	2.6	—	L12	82FA-20H-31
	Cuspid	-11°	7°	2.8	—	LL3	-
						W	82FA-21H-33
						—	-
	1st Bicuspid	-17°	0°	2.8	—	LR3	82FA-21H-43
						W	82FA-20H-34
						—	82FA-21H-34
	2nd Bicuspid	-22°	0°	2.8	—	LR5	82FA-20H-44
						W	82FA-21H-44
						—	82FA-20H-35
						LL5	82FA-21H-35
						W	82FA-20H-45
—						82FA-21H-45	

Bracket Kits	0.022	
	Upper/Low er 5x5 Hook on 3	82FA-23H
	Upper/Low er 5x5 Hook on 3,4,& 5	82FA-25H

- High-setted wings ensure enough ligature space and easy transformation between different sizes of wires
- Surface roughness $\leq 0.13\mu\text{m}$, slot accuracy $\leq 0.02\text{mm}$, results in full performing in three order bend
- Rounded and polished surface finishing conforms to ergonomics and for patients' comfort.
- Special designed clip prevents deformation/falling off during installation/occlusion
- 17-4 material for high strength, corrosion resistance, no deformation
- Special alloy brazing for superior brackets-to-base bonding strength



FLEX-M5 Series

MBT*

	Tooth	Torq.	Ang.	M/D Width	Hook	L/R	.022 Slot
	Maxillary	Central	17°	4°	2.8	—	UR1
UL1							83FA-20H-21
Lateral		10°	8°	2.8	—	UR2	83FA-20H-12
						UL2	83FA-20H-22
Cuspid		-7°	8°	2.8	—	UR3	-
						W	83FA-21H-13
	—					-	
1st Bicuspid	-7°	0°	2.8	—	UR4	83FA-20H-14	
					W	83FA-21H-14	
					—	83FA-20H-24	
2nd Bicuspid	-7°	0°	2.8	—	UL4	83FA-21H-24	
					W	83FA-20H-15	
					—	83FA-21H-15	
					UR5	83FA-20H-25	
					W	83FA-21H-25	
					—	83FA-21H-25	
Mandibular	Anteriors	-6°	0°	2.6	—	L12	83FA-20H-31
	Cuspid	-6°	3°	2.8	—	LL3	83FA-20H-41
						W	83FA-20H-33
						—	83FA-21H-33
	1st Bicuspid	-12°	0°	2.8	—	LR3	83FA-20H-43
						W	83FA-21H-43
						—	83FA-20H-34
	2nd Bicuspid	-17°	0°	2.8	—	LL4	83FA-21H-34
						W	83FA-20H-44
						—	83FA-21H-44
						LR5	83FA-20H-35
						W	83FA-21H-35
—						83FA-20H-45	
					LL5	83FA-21H-45	
					W		
					—		

Bracket Kits	0.022	
	Upper/Low er 5x5 Hook on 3	83FA-23H
	Upper/Low er 5x5 Hook on 3,4,& 5	83FA-25H



Self-ligating Brackets
Ceramic Brackets
Lingual Brackets
Metal Brackets
Buccal tubes
Bands
Archwires
Accessories
Elastomers
Instruments

FLEX-C Series

ROTH

	Tooth	Torq.	Ang.	M/D Width	Hook	L/R	.022 Slot
	Maxillary	Central	12°	5°	3.1	—	UR1
UL1							82FH-20G-21
Lateral		8°	9°	2.85	—	UR2	82FH-20G-12
						UL2	82FH-20G-22
Cuspid		-2°	11°	3.4	W	UR3	82FH-21G-13
						UL3	82FH-21G-23
1st & 2nd Bicuspid	-7°	0°	3.1	W	UR4/5	82FH-21G-14	
					UL4/5	82FH-21G-24	
Mandibular	Anteriors	-1°	0°	2.85	—	L12	82FH-20G-31
	Cuspid	-11°	7°	3.5	W	LL3	82FH-21G-33
					W	LR3	82FH-21G-43
	1st Bicuspid	-17°	0°	3.2	W	LL4	82FH-21G-34
					W	LR4	82FH-20G-44
	2nd Bicuspid	-22°	0°	3.2	W	LL5	82FH-21G-35
					W	LR5	82FH-20G-45

Bracket Kits	0.022	
	Upper/Low er 5x5 Hook on 3,4,& 5	82FH-25G

FLEX-C Series

MBT* (Coming Soon)

	Tooth	Torq.	Ang.	M/D Width	Hook	L/R	.022 Slot
	Maxillary	Central	17°	4°	3.5	—	UR1
UL1							83FH-20G-21
Lateral		10°	8°	3.0	—	UR2	83FH-20G-12
						UL2	83FH-20G-22
Cuspid		0°	8°	3.5	W	UR3	83FH-21G-13
						UL3	83FH-21G-23
1st & 2nd Bicuspid	-7°	0°	3.2	W	UR4	82FH-21G-14	
					UL4	82FH-21G-24	
					UR5	82FH-21G-15	
					UL5	82FH-21G-25	
Mandibular	Anteriors	-6°	0°	2.5	—	LL1/2	83FH-20G-31
	Cuspid	0°	3°	3.5	W	LL3	83FH-21G-33
					W	LR3	83FH-21G-43
	1st Bicuspid	-12°	2°	3.2	W	LL4	83FH-21G-34
					W	LR4	83FH-20G-44
	2nd Bicuspid	-17°	2°	3.2	W	LL5	83FH-21G-35
					W	LR5	83FH-20G-45

Bracket Kits	0.022	
	Upper/Low er 5x5 Hook on 3,4,& 5	83FH-25G

1 Body rounding for patents' comfort

2 Round ball contact engineering method on specialized clip for less wire contact and best sliding effect

3 Low profile height for patients' less foreign body sensation

4 The optimal base for superior at bonding/debonding



Identification system

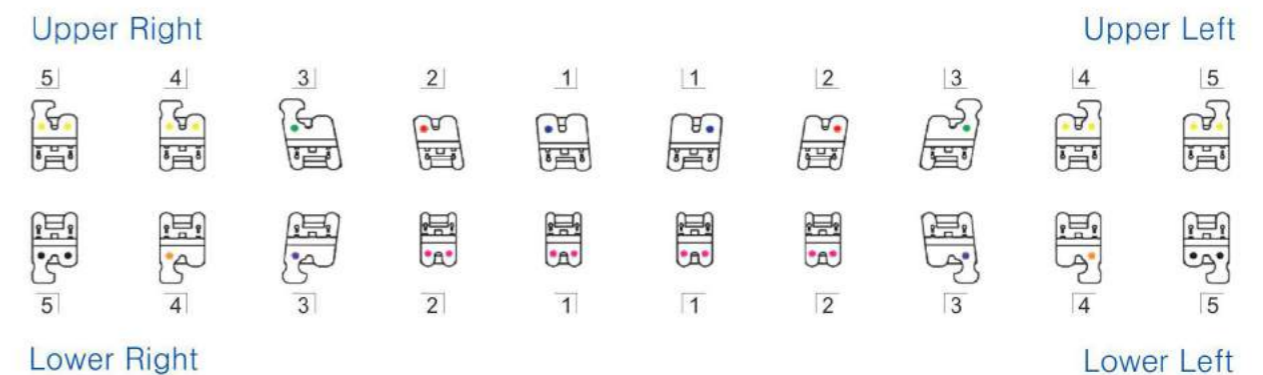

- Self-ligating Brackets
- Ceramic Brackets
- Lingual Brackets
- Metal Brackets
- Buccal tubes
- Bands
- Archwires
- Accessories
- Elastomers
- Instruments

CERAMIC BRACKETS

Ceramic Brackets

Galaxy C Series 2.03

Galaxy Iclear Series 2.05



Ceramic Brackets

GALAXY C Series



- 1 True twin wings for flexible treatment and ligation
Rounded edge for patient comfort.
- 2 Hollow design in slot centre to reduce the frictional force.
- 3 Chamfered base for easy debonding.
- 4 Ceramic Injection Method(CIM Method) to be remarkable durability.
- 5 Vertical scribe line for easy and accurate positioning.

Galaxy C Series

ROTH

	Tooth	Torq.	Ang.	M/D Width	Hook	L/R	.022 Slot
	Maxillary	Central	12°	5°	3.5	—	UR1
UL1							821H-20N-21
Lateral		8°	9°	3.1	—	UR2	821H-20N-12
						UL2	821H-20N-22
Cuspid		0°	11°	3.4	—	UR3	821H-20N-13
					W		821H-21N-13
					—	UL3	821H-20N-23
W		821H-21N-23					
1st & 2nd Bicuspid		-7°	0°	3.1	—	UR45	821H-20N-14
					W		821H-21N-14
	—				UL45	821H-20N-24	
W	821H-21N-24						
Mandibular	Anteriors	-1°	0°	2.9	—	L12	821H-20N-31
	Cuspid	-11°	7°	3.4	—	LL3	821H-20N-33
					W		821H-21N-33
					—	LR3	821H-20N-43
	W	821H-21N-43					
	1st Bicuspid	-17°	0°	3.1	—	LL4	821H-20N-34
					W		821H-21N-34
					—	LR4	821H-20N-44
	W	821H-21N-44					
	2nd Bicuspid	-22°	0°	3.1	—	LL5	821H-20N-35
W					821H-21N-35		
—					LR5	821H-20N-45	
W	821H-21N-45						

Bracket Kits	0.022	
	Upper/Low er 5x5 No Hook	821H-20N
	Upper/Low er 5x5 Hook on 3	821H-23N
	Upper/Low er 5x5 Hook on 3,4,& 5	821H-25N

- Self-ligating Brackets
- Ceramic Brackets
- Lingual Brackets
- Metal Brackets
- Buccal tubes
- Bands
- Archwires
- Accessories
- Elastomers
- Instruments

Galaxy Iclear Series

ROTH

	Tooth	Torq.	Ang.	M/D Width	Hook	L/R	.018 Slot		.022 Slot	
Maxillary	Central	12°	5°	3.5	—	UR1	821H-10J-11	821H-20J-11		
						UL1	821H-10J-21	821H-20J-21		
	Lateral	8°	9°	3.2	—	UR2	821H-10J-12	821H-20J-12		
						UL2	821H-10J-22	821H-20J-22		
	Cuspid	-2°	11°	3.3	W	UR3	821H-11J-13	821H-21J-13		
					W	UL3	821H-11J-23	821H-21J-23		
	1st & 2nd Bicuspid	-7°	0°	3.0	—	UR45	821H-10J-14	821H-20J-14		
					W		821H-11J-14	821H-21J-14		
—					UL45	821H-10J-24	821H-20J-24			
W						821H-11J-24	821H-21J-24			
Mandibular	Anteriors	0°	0°	2.8	—	L12	821H-10J-31	821H-20J-31		
	Cuspid	-11°	7°	3.3	W	LL3	821H-11J-33	821H-20J-33		
					W	LR3	821H-11J-43	821H-21J-43		
	1st Bicuspid	-17°	0°	3.2	—	LL4	821H-10J-34	821H-20J-34		
					W		821H-11J-34	821H-21J-34		
					—	LR4	821H-10J-44	821H-20J-44		
					W		821H-11J-44	821H-21J-44		
	2nd Bicuspid	-22°	0°	3.2	—	LL5	821H-10J-35	821H-20J-35		
					W		821H-11J-35	821H-21J-35		
					—	LR5	821H-10J-45	821H-20J-45		
					W		821H-11J-45	821H-21J-45		

Bracket Kits	0.018		0.022	
	Upper/Low er 5x5 Hook on 3	821H-13J		821H-23J
	Upper/Low er 5x5 Hook on 3,4,& 5	821H-15J		821H-25J

Galaxy Iclear Series

MBT*

	Tooth	Torq.	Ang.	M/D Width	Hook	L/R	.018 Slot		.022 Slot	
Maxillary	Central	17°	4°	3.5	—	UR1	831H-10J-11	831H-20J-11		
						UL1	831H-10J-21	831H-20J-21		
	Lateral	10°	8°	3.2	—	UR2	831H-10J-12	831H-20J-12		
						UL2	831H-10J-22	831H-20J-22		
	Cuspid	0°	8°	3.5	W	UR3	831H-11J-13	831H-21J-13		
					W	UL3	831H-11J-23	831H-21J-23		
	1st & 2nd Bicuspid	-7°	0°	3.2	—	UR45	831H-10J-14	831H-20J-14		
					W		831H-11J-14	831H-21J-14		
—					UL45	831H-10J-24	831H-20J-24			
W						831H-11J-24	831H-21J-24			
Mandibular	Anteriors	-6°	0°	2.8	—	L12	831H-10J-31	831H-20J-31		
	Cuspid	0°	3°	3.6	W	LL3	831H-11J-33	831H-20J-33		
					W	LR3	831H-11J-43	831H-21J-43		
	1st Bicuspid	-12°	2°	3.2	—	LL4	831H-10J-34	831H-20J-34		
					W		831H-11J-34	831H-21J-34		
					—	LR5	831H-10J-44	831H-20J-44		
					W		831H-11J-44	831H-21J-44		
	2nd Bicuspid	-17°	2°	3.2	—	LL5	831H-10J-35	831H-20J-35		
					W		831H-11J-35	831H-21J-35		
					—	LR5	831H-10J-45	831H-20J-45		
					W		831H-11J-45	831H-21J-45		

Bracket Kits	0.018		0.022	
	Upper/Low er 5x5 Hook on 3	831H-13J		831H-23J
	Upper/Low er 5x5 Hook on 3,4,& 5	831H-15J		831H-25J

GALAXY Iclear



- 1 True twin wings and low profile design for excellent performance
- 2 Rounded edge and full body coating for ultra smooth patients' comfort
- 3 The world's first 2 step groove for easy and accurate positioning
- 4 Plasma silica coating in the slot for superior sliding and minimize fracture
- 5 Half base coating for superior retention and easy debonding



Self-ligating Brackets
Ceramic Brackets
Lingual Brackets
Metal Brackets
Buccal tubes
Bands
Archwires
Accessories
Elastomers
Instruments

Lingual Brackets

Lingual Self-Ligating Brackets 3.03

Lingual Brackets 3.04



Lingual Brackets

Lingual self-ligating Brackets

Maxillary	Tooth	Torq.	Ang.	M/D Width	Hook	L/R	.018 Slot
	Central	40°	0°	1.5	—	U123	8A31-10H-11
	Lateral						
	Cuspid						
1st & 2nd Bicuspid	11°	0°	1.5	—	U45	8A31-10H-14	
Mandibular	Anteriors	40°	0°	1.5	—	L123	8A31-10H-11
	Cuspid						
	1st Bicuspid	11°	0°	1.5	—	L45	8A31-10H-14
	2nd Bicuspid						

Bracket Kits	0.018	
	Upper/Lower 5x5 No Hook	8A31-10H



- 1.Unique self-ligating design, with simple operation, reliable structure.
2. Perfect combination of the vertical slot(anterior) and horizontal slot(posterior);
3. Stainless steel of a new special type possesses large rigidity and good tenacity;overall machining ensures rare deformation;
4. Main arch wire slot is processed by unique original technology with higher precision,smooth and clean bottom,realizing free sliding;
5. 80 mesh net stays in initial condition, enhancing the retention force between bracket bottom and teeth substantially;
6. Sufficient space of pterygoid hamulus favors the ligation;
7. Proprietary intellectual property right of the product is obtained.

Lingual Brackets

Maxillary	Tooth	Torq.	Ang.	M/D Width	Hook	L/R	.018 Slot
	Central	40°	0°	1.5	—	U123	8A21-10H-11
	Lateral						
	Cuspid						
1st & 2nd Bicuspid	11°	0°	1.5	—	U45	8A21-10H-14	
Mandibular	Anteriors	40°	0°	1.5	—	L123	8A21-10H-11
	Cuspid						
	1st Bicuspid	11°	0°	1.5	—	L45	8A21-10H-14
	2nd Bicuspid						

Bracket Kits	0.018	
	Upper/Lower 5x5 No Hook	8A21-10H



1. Two varieties with hook and no hook are available.
2. Perfect combination of the vertical slot (anterior) and horizontal slot (posterior) .
3. Stainless steel of a new special type possesses large rigidity and good tenacity; overall machining ensures rare deformation;
4. Main arch wire slot is processed by unique original technology with higher precision, smooth and clean bottom, realizing free sliding.
5. 80 mesh net stays in initial condition, enhancing the retention force between bracket bottom and teeth substantially.
6. Sufficient space of pterygoid hamulus favor the ligation.
7. Proprietary intellectual property right of the product is obtained

Metal Brackets

Vertical Slot Brackets	4.03
Ricketts Brackets	4.04
Tweed Brackets	4.05
Begg Brackets	4.05
Confidence Series Brackets	4.07
Distinction Series Brackets	4.15
Elite Series Brackets	4.17
E-PLUS Series Brackets	4.19
Physiological Anchorage Spee's-wire (PASS)	4.21

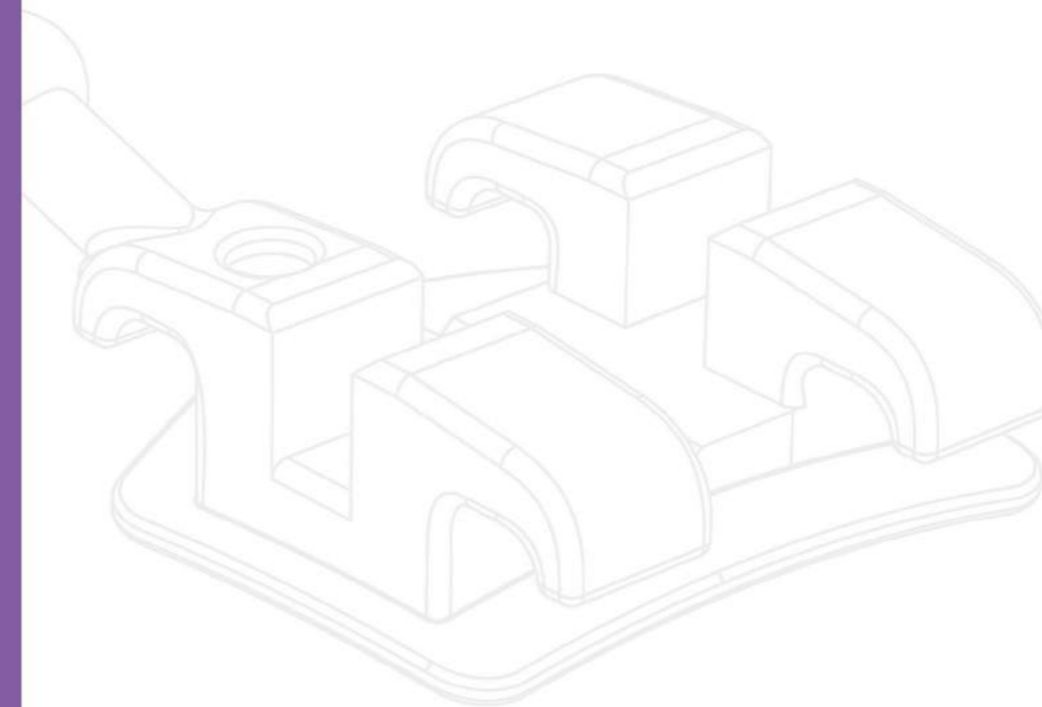

Metal Brackets

Mini Vertical Slot Roth Brackets

	Tooth	Torq.	Ang.	M/D Width	Hook	L/R	.018 Slot		.022 Slot	
Maxillary	Central	8°	5°	3.2	—	UR1	8245-10B-11	8245-20B-11		
						UL1	8245-10B-21	8245-20B-21		
	Lateral	8°	9°	2.8	—	UR2	8245-10B-12	8245-20B-12		
						UL2	8245-10B-22	8245-20B-22		
	Cuspid	-2°	11°	2.9	—	UR3	8245-10B-13	8245-20B-13		
							8245-11B-13	8245-21B-13		
						UL3	8245-10B-23	8245-20B-23		
							8245-11B-23	8245-21B-23		
	1st & 2nd Bicuspid	-7°	0°	2.8	—	UR4/5	8245-10B-14	8245-20B-14		
							8245-11B-14	8245-21B-14		
UL4/5						8245-10B-24	8245-20B-24			
						8245-11B-24	8245-21B-24			
Mandibular	Anteriors	0°	0°	2.6	—	L12	8245-10B-31	8245-20B-31		
	Cuspid	-11°	5°	2.8	—	LL3	8245-10B-33	8245-20B-33		
							8245-11B-33	8245-21B-33		
						LR3	8245-10B-43	8245-20B-43		
							8245-11B-43	8245-21B-43		
	1st Bicuspid	-17°	0°	2.8	—	LL4	8245-10B-34	8245-20B-34		
							8245-11B-34	8245-21B-34		
						LR4	8245-10B-44	8245-20B-44		
							8245-11B-44	8245-21B-44		
	2nd Bicuspid	-22°	0°	2.8	—	LL5	8245-10B-35	8245-20B-35		
							8245-11B-35	8245-21B-35		
						LR5	8245-10B-45	8245-20B-45		
							8245-11B-45	8245-21B-45		

Bracket Kits	0.018		0.022	
	Upper/Low er 5x5 No Hook	8245-10B	8245-20B	
	Upper/Low er 5x5 Hook on 3	8245-13B	8245-23B	
	Upper/Low er 5x5 Hook on 3,4,& 5	8245-15B	8245-25B	

Mini Low Profile Ricketts Brackets

	Tooth	Torq.	Ang.	M/D Width	Hook	L/R	.018 Slot		.022 Slot	
Maxillary	Central	22°	0°	3.2	—	UR1	8815-10B-11	8815-20B-11		
						UL1	8815-10B-21	8815-20B-21		
	Lateral	14°	8°	2.6	—	UR2	8815-10B-12	8815-20B-12		
						UL2	8815-10B-22	8815-20B-22		
	Cuspid	7°	5°	3.0	—	UR3	8815-10B-13	8815-20B-13		
							8815-11B-13	8815-21B-13		
						UL3	8815-10B-23	8815-20B-23		
							8815-11B-23	8815-21B-23		
	1st & 2nd Bicuspid	0°	0°	2.8	—	UR4/5	8815-10B-14	8815-20B-14		
							8815-11B-14	8815-21B-14		
UL4/5						8815-10B-24	8815-20B-24			
						8815-11B-24	8815-21B-24			
Mandibular	Anteriors	-1°	0°	2.3	—	L12	8815-10B-31	8815-20B-31		
	Cuspid	7°	5°	2.8	—	LL3	8815-10B-33	8815-20B-33		
							8815-11B-33	8815-21B-33		
						LR3	8815-10B-43	8815-20B-43		
							8815-11B-43	8815-21B-43		
	1st Bicuspid	0°	0°	2.8	—	LL4	8815-10B-34	8815-20B-34		
							8815-11B-34	8815-21B-34		
						LR4	8815-10B-44	8815-20B-44		
							8815-11B-44	8815-21B-44		
	2nd Bicuspid	-11°	0°	2.8	—	LL5	8815-10B-35	8815-20B-35		
							8815-11B-35	8815-21B-35		
						LR5	8815-10B-45	8815-20B-45		
							8815-11B-45	8815-21B-45		

Bracket Kits	0.018		0.022	
	Upper/Low er 5x5 No Hook	8815-10B	8815-20B	
	Upper/Low er 5x5 Hook on 3	8815-13B	8815-23B	
	Upper/Low er 5x5 Hook on 3,4,& 5	8815-15B	8815-25B	

- Self-ligating Brackets
- Ceramic Brackets
- Lingual Brackets
- Metal Brackets**
- Buccal Tubes
- Bands
- Archwires
- Accessories
- Elastomers
- Instruments

Standard Tweed Brackets



Maxillary	Tooth	Torq.	Ang.	M/D Width	Hook	L/R	.018 Slot	.022 Slot
	Central	0°	0°	2.6	—	U1	8176-10B-11	8176-20B-11
	Lateral	0°	0°	2.6	—	U2	8176-10B-12	8176-20B-12
	Anteriors	0°	0°	2.1	—	L12	8176-10B-31	8176-20B-31
	Cuspid	0°	0°	2.6	—	U3/L3	8176-10B-13	8176-20B-13
	1st & 2nd Bicuspid	0°	0°	2.1	—	U45/L45	8176-10B-14	8176-20B-14

Bracket Kits	0.018		0.022	
	Upper/Low er 5x5 No Hook	8176-10B		8176-20B

Begg Brackets

ROTH

Bracket Kits	Photo	Tooth	Item No.
		Anteriors	8911
	Lateral	8912	

1st Molar Weldable Brackets

Maxillary									
Photo	Sys.	Torq.	Distal Offset	Length (mm)	L/R	W/O Hook		W Hook	
						.018	.022	.018	.022
	Edgewise	0°	0°	3.6	UR	8151-10A-16	8151-20A-16	8151-11A-16	8151-21A-16
					UL	8151-10A-26	8151-20A-26	8151-11A-26	8151-21A-26
	Roth	-14°	10°	3.8	UR	8251-10B-16	8251-20B-16	8251-11B-16	8251-21B-16
					UL	8251-10B-26	8251-20B-26	8251-11B-26	8251-21B-26
	MBT*	-14°	10°	3.8	UR	8351-10B-16	8351-20B-16	8351-11B-16	8351-21B-16
					UL	8351-10B-26	8351-20B-26	8351-11B-26	8351-21B-26

Mandibular									
Photo	Sys.	Torq.	Distal Offset	Length (mm)	L/R	W/O Hook		W Hook	
						.018	.022	.018	.022
	Edgewise	0°	0°	3.6	LR	8151-10A-46	8151-20A-46	8151-11A-46	8151-21A-46
					LL	8151-10A-36	8151-20A-36	8151-11A-36	8151-21A-36
	Roth	-25°	4°	3.8	LR	8251-10B-46	8251-20B-46	8251-11B-46	8251-21B-46
					LL	8251-10B-36	8251-20B-36	8251-11B-36	8251-21B-36
	MBT*	-20°	4°	3.8	LR	8351-10B-46	8351-20B-46	8351-11B-46	8351-21B-46
					LL	8351-10B-36	8351-20B-36	8351-11B-36	8351-21B-36

1st Molar Bondable Brackets

Maxillary							
Photo	Sys.	Torq.	Distal Offset	Length (mm)	L/R	C-Series	
						.018	.022
	Edgewise	0°	0°	3.6	UR	8154-10A-16	8154-20A-16
					UL	8154-10A-26	8154-20A-26
	Roth	-14°	10°	3.8	UR	8254-10B-16	8254-20B-16
					UL	8254-10B-26	8254-20B-26
	MBT*	-14°	10°	3.8	UR	8354-10B-16	8354-20B-16
					UL	8354-10B-26	8354-20B-26

Mandibular							
Photo	Sys.	Torq.	Distal Offset	Length (mm)	L/R	C-Series	
						.018	.022
	Edgewise	0°	0°	3.6	LR	8154-10A-46	8154-20A-46
					LL	8154-10A-36	8154-20A-36
	Roth	-25°	4°	3.8	LR	8254-10B-46	8254-20B-46
					LL	8254-10B-36	8254-20B-36
	MBT*	-20°	0°	3.8	LR	8354-10B-46	8354-20B-46
					LL	8354-10B-36	8354-20B-36

Self-ligating Brackets
Ceramic Brackets
Lingual Brackets
Metal Brackets
Buccal tubes
Bands
Archwires
Accessories
Elastomers
Instruments

CONFIDENCE Series

Standard Edgewise Brackets

Maxillary	Tooth	Torq.	Ang.	M/D Width	Hook	L/R	.018 Slot	.022 Slot
	Central	0°	0°	3.3	—	UR1	8118-10B-11	8118-20B-11
						UL1		
	Lateral	0°	0°	3.0	—	UR2	8118-10B-12	8118-20B-12
						UL2		
	Anteriors	0°	0°	2.5	—	LR12	8118-10B-31	8118-20B-31
						LL12		
	Cuspid	0°	0°	3.3	—	U3	8118-10B-13	8118-20B-13
						L3		
					W	UR3	8118-11B-13	8118-21B-13
LL3								
W	UL3	8118-11B-23	8118-21B-23					
	LR3							
1st & 2nd Bicuspid	0°	0°	3.0	—	U45	8118-10B-14	8118-20B-14	
					L45			
				W	UR45	8118-11B-14	8118-21B-14	
					LL45			
				W	UL45	8118-11B-24	8118-21B-24	
					LR45			

Bracket Kits	0.018		0.022	
	Upper/Low er 5x5 No Hook	8116-10B		8116-20B
	Upper/Low er 5x5 Hook on 3	8116-13B		8116-23B
	Upper/Low er 5x5 Hook on 3,4, & 5	8116-15B		8116-25B

CONFIDENCE Series

Mini Edgewise Brackets

Maxillary	Tooth	Torq.	Ang.	M/D Width	Hook	L/R	.018 Slot	.022 Slot
	Central	0°	0°	3.0	—	UR1	8117-10B-11	8117-20B-11
						UL1		
	Lateral	0°	0°	2.7	—	UR2	8117-10B-12	8117-20B-12
						UL2		
	Anteriors	0°	0°	2.3	—	LL12	8117-10B-31	8117-20B-31
						LR12		
	Cuspid	0°	0°	3.0	—	U3	8117-10B-13	8117-20B-13
						L3		
					W	UR3	8117-11B-13	8117-21B-13
LL3								
W	UL3	8117-11B-23	8117-21B-23					
	LR3							
1st & 2nd Bicuspid	0°	0°	2.7	—	U45	8117-10B-14	8117-20B-14	
					L45			
				W	UR4/5	8117-11B-14	8117-21B-14	
					LL4/5			
				W	UL4/5	8117-11B-24	8117-21B-24	
					LR4/5			

Bracket Kits	0.018		0.022	
	Upper/Low er 5x5 No Hook	8115-10B		8115-20B
	Upper/Low er 5x5 Hook on 3	8115-13B		8115-23B
	Upper/Low er 5x5 Hook on 3,4, & 5	8115-15B		8115-25B

CONFIDENCE Series



- Torque in base for level slot lineup
- 80 gauge mesh bonding base match the anatomy of the tooth for maximum contact and a strong, consistent bond
- Rounded tie wing for patient comfort

- Self-ligating Brackets
- Ceramic Brackets
- Lingual Brackets
- Metal Brackets**
- Buccal Tubes
- Bands
- Archwires
- Accessories
- Elastomers
- Instruments

CONFIDENCE Series

Standard Roth Brackets

	Tooth	Torq.	Ang.	M/D Width	Hook	L/R	.018 Slot	.022 Slot
	Maxillary	Central	12°	5°	3.4	—	UR1	8218-10B-11
UL1							8218-10B-21	8218-20B-21
Lateral		8°	9°	2.9	—	UR2	8218-10B-12	8218-20B-12
						UL2	8218-10B-22	8218-20B-22
Cuspid		-2°	11°	3.0	—	UR3	8218-10B-13	8218-20B-13
							8218-11B-13	8218-21B-13
						UL3	8218-10B-23	8218-20B-23
							8218-11B-23	8218-21B-23
1st & 2nd Bicuspid		-7°	0°	2.9	—	UR45	8218-10B-14	8218-20B-14
							8218-11B-14	8218-21B-14
	UL45					8218-10B-24	8218-20B-24	
						8218-11B-24	8218-21B-24	
Mandibular	Anteriors	-1°	2°	2.5	—	LL12	8218-10B-31	8218-20B-31
						LR12	8218-10B-41	8218-20B-41
	Cuspid	-11°	5°	2.9	—	LL3	8218-10B-33	8218-20B-33
							8218-11B-33	8218-21B-33
						LR3	8218-10B-43	8218-20B-43
							8218-11B-43	8218-21B-43
	1st Bicuspid	-17°	0°	2.9	—	LL4	8218-10B-34	8218-20B-34
							8218-11B-34	8218-21B-34
						LR4	8218-10B-44	8218-20B-44
							8218-11B-44	8218-21B-44
	2nd Bicuspid	-22°	0°	2.9	—	LL5	8218-10B-35	8218-20B-35
							8218-11B-35	8218-21B-35
						LR5	8218-10B-45	8218-20B-45
							8218-11B-45	8218-21B-45

Bracket Kits	0.018		0.022	
	Upper/Lower 5x5 No Hook	8218-10B	8218-20B	
	Upper/Lower 5x5 Hook on 3	8218-13B	8218-23B	
	Upper/Lower 5x5 Hook on 3,4,& 5	8218-15B	8218-25B	

CONFIDENCE Series

Standard MBT* Brackets

	Tooth	Torq.	Ang.	M/D Width	Hook	L/R	.018 Slot	.022 Slot
	Maxillary	Central	17°	4°	3.6	—	UR1	8318-10B-11
UL1							8318-10B-21	8318-20B-21
Lateral		10°	8°	2.8	—	UR2	8318-10B-12	8318-20B-12
						UL2	8318-10B-22	8318-20B-22
Cuspid		-7°	8°	3.0	—	UR3	8318-10B-13	8318-20B-13
							8318-11B-13	8318-21B-13
						UL3	8318-10B-23	8318-20B-23
							8318-11B-23	8318-21B-23
1st Bicuspid		-7°	0°	3.0	—	UR4	8318-10B-14	8318-20B-14
							8318-11B-14	8318-21B-14
	UL4					8318-10B-24	8318-20B-24	
						8318-11B-24	8318-21B-24	
2nd Bicuspid	-7°	0°	3.0	—	UR5	8318-10B-15	8318-20B-15	
						8318-11B-15	8318-21B-15	
					UL5	8318-10B-25	8318-20B-25	
						8318-11B-25	8318-21B-25	
Mandibular	Anteriors	-6°	0°	2.7	—	L12	8318-10B-31	8318-20B-31
	Cuspid	-6°	3°	3.0	—	LL3	8318-10B-33	8318-20B-33
							8318-11B-33	8318-21B-33
						LR3	8318-10B-43	8318-20B-43
							8318-11B-43	8318-21B-43
	1st Bicuspid	-12°	2°	3.0	—	LL4	8318-10B-34	8318-20B-34
							8318-11B-34	8318-21B-34
						LR4	8318-10B-44	8318-20B-44
							8318-11B-44	8318-21B-44
	2nd Bicuspid	-17°	2°	3.0	—	LL5	8318-10B-35	8318-20B-35
							8318-11B-35	8318-21B-35
						LR5	8318-10B-45	8318-20B-45
							8318-11B-45	8318-21B-45

Bracket Kits	0.018		0.022	
	Upper/Lower 5x5 No Hook	8318-10B	8318-20B	
	Upper/Lower 5x5 Hook on 3	8318-13B	8318-23B	
	Upper/Lower 5x5 Hook on 3,4,& 5	8318-15B	8318-25B	

- Self-ligating Brackets
- Ceramic Brackets
- Lingual Brackets
- Metal Brackets**
- Buccal tubes
- Bands
- Archwires
- Accessories
- Elastomers
- Instruments

CONFIDENCE Series

Mini Roth Brackets

	Tooth	Torq.	Ang.	M/D Width	Hook	L/R	Slot	
							.018 Slot	.022 Slot
Maxillary	Central	12°	5°	3.1	—	UR1	8217-10B-11	8217-20B-11
						UL1	8217-10B-21	8217-20B-21
	Lateral	8°	9°	2.8	—	UR2	8217-10B-12	8217-20B-12
						UL2	8217-10B-22	8217-20B-22
	Cuspid	-2°	11°	2.8	—	UR3	8217-10B-13	8217-20B-13
							8217-11B-13	8217-21B-13
						UL3	8217-10B-23	8217-20B-23
							8217-11B-23	8217-21B-23
	1st & 2nd Bicuspid	-7°	0°	2.8	—	UR45	8217-10B-14	8217-20B-14
							8217-11B-14	8217-21B-14
UL45						8217-10B-24	8217-20B-24	
						8217-11B-24	8217-21B-24	
Mandibular	Anteriors	-1°	2°	2.3	—	LL12	8217-10B-31	8217-20B-31
						LR12	8217-10B-41	8217-20B-41
	Cuspid	-11°	5°	2.8	—	LL3	8217-10B-33	8217-20B-33
							8217-11B-33	8217-21B-33
						LR3	8217-10B-43	8217-20B-43
							8217-11B-43	8217-21B-43
	1st Bicuspid	-17°	0°	2.8	—	LL4	8217-10B-34	8217-20B-34
							8217-11B-34	8217-21B-34
						LR4	8217-10B-44	8217-20B-44
							8217-11B-44	8217-21B-44
	2nd Bicuspid	-22°	0°	2.8	—	LL5	8217-10B-35	8217-20B-35
							8217-11B-35	8217-21B-35
						LR5	8217-10B-45	8217-20B-45
							8217-11B-45	8217-21B-45

Bracket Kits	0.018		0.022	
	Upper/Lower 5x5 No Hook	8217-10B	8217-20B	
	Upper/Lower 5x5 Hook on 3	8217-13B	8217-23B	
	Upper/Lower 5x5 Hook on 3,4, & 5	8217-15B	8217-25B	

CONFIDENCE Series

Mini MBT* Brackets

	Tooth	Torq.	Ang.	M/D Width	Hook	L/R	Slot	
							.018 Slot	.022 Slot
Maxillary	Central	17°	4°	3.1	—	UR1	8317-10B-11	8317-20B-11
						UL1	8317-10B-21	8317-20B-21
	Lateral	10°	8°	2.8	—	UR2	8317-10B-12	8317-20B-12
						UL2	8317-10B-22	8317-20B-22
	Cuspid	-7°	8°	2.8	—	UR3	8317-10B-13	8317-20B-13
							8317-11B-13	8317-21B-13
						UL3	8317-10B-23	8317-20B-23
							8317-11B-23	8317-21B-23
	1st & 2nd Bicuspid	-7°	0°	2.8	—	UR45	8317-10B-14	8317-20B-14
							8317-11B-14	8317-21B-14
UL45						8317-10B-24	8317-20B-24	
						8317-11B-24	8317-21B-24	
Mandibular	Anteriors	-6°	0°	2.3	—	L12	8317-10B-31	8317-20B-31
	Cuspid	-6°	3°	2.8	—	LL3	8317-10B-33	8317-20B-33
							8317-11B-33	8317-21B-33
						LR3	8317-10B-43	8317-20B-43
							8317-11B-43	8317-21B-43
	1st Bicuspid	-12°	2°	2.8	—	LL4	8317-10B-34	8317-20B-34
							8317-11B-34	8317-21B-34
						LR4	8317-10B-44	8317-20B-44
							8317-11B-44	8317-21B-44
	2nd Bicuspid	-17°	2°	2.8	—	LL5	8317-10B-35	8317-20B-35
							8317-11B-35	8317-21B-35
						LR5	8317-10B-45	8317-20B-45
							8317-11B-45	8317-21B-45

Bracket Kits	0.018		0.022	
	Upper/Lower 5x5 No Hook	8318-10B	8318-20B	
	Upper/Lower 5x5 Hook on 3	8318-13B	8318-23B	
	Upper/Lower 5x5 Hook on 3,4, & 5	8318-15B	8318-25B	

- Self-ligating Brackets
- Ceramic Brackets
- Lingual Brackets
- Metal Brackets**
- Buccal Tubes
- Bands
- Archwires
- Accessories
- Elastomers
- Instruments

CONFIDENCE Series

Mini Low Profile Roth Brackets

	Tooth	Torq.	Ang.	M/D Width	Hook	L/R	.018 Slot	.022 Slot	
	Maxillary	Central	12°	5°	3.2	—	UR1	8277-10C-11	8277-20C-11
UL1							8277-10C-21	8277-20C-21	
Lateral		8°	9°	2.9	—	UR2	8277-10C-12	8277-20C-12	
						UL2	8277-10C-22	8277-20C-22	
Cuspid		-2°	11°	2.9	—	UR3	8277-10C-13	8277-20C-13	
							W	8277-11C-13	8277-21C-13
						UL3	—	8277-10C-23	8277-20C-23
							W	8277-11C-23	8277-21C-23
1st & 2nd Bicuspid		-7°	0°	2.9	—	UR45	8277-10C-14	8277-20C-14	
							W	8277-11C-14	8277-21C-14
	UL45					—	8277-10C-24	8277-20C-24	
						W	8277-11C-24	8277-21C-24	
Mandibular	Anteriors	0°	0°	2.5	—	L12	8277-10C-31	8277-20C-31	
	Cuspid	-11°	5°	2.9	—	LL3	8277-10C-33	8277-20C-33	
							W	8277-11C-33	8277-21C-33
						LR3	—	8277-10C-43	8277-20C-43
							W	8277-11C-43	8277-21C-43
	1st Bicuspid	-17°	0°	2.9	—	LL4	8277-10C-34	8277-20C-34	
							W	8277-11C-34	8277-21C-34
						LR4	—	8277-10C-44	8277-20C-44
							W	8277-11C-44	8277-21C-44
	2nd Bicuspid	-22°	0°	2.9	—	LL5	8277-10C-35	8277-20C-35	
							W	8277-11C-35	8277-21C-35
						LR5	—	8277-10C-45	8277-20C-45
							W	8277-11C-45	8277-21C-45

Bracket Kits	0.018		0.022	
	Upper/Lower 5x5 No Hook	8277-10C		8277-20C
	Upper/Lower 5x5 Hook on 3	8277-13C		8277-23C
	Upper/Lower 5x5 Hook on 3,4,& 5	8277-15C		8277-25C

CONFIDENCE Series

Mini Low Profile MBT* Brackets

	Tooth	Torq.	Ang.	M/D Width	Hook	L/R	.018 Slot	.022 Slot			
	Maxillary	Central	17°	4°	3.2	—	UR1	8377-10C-11	8377-20C-11		
UL1							8377-10C-21	8377-20C-21			
Lateral		10°	8°	2.9	—	UR2	8377-10C-12	8377-20C-12			
						UL2	8377-10C-22	8377-20C-22			
Cuspid		-7°	8°	2.9	—	UR3	8377-10C-13	8377-20C-13			
							W	8377-11C-13	8377-21C-13		
						UL3	-7°	8°	—	8377-10C-23	8377-20C-23
							0°	0°	W	8377-11C-23	8377-21C-23
1st & 2nd Bicuspid		-7°	0°	2.9	—	UR45	8377-10C-14	8377-20C-14			
							W	8377-11C-14	8377-21C-14		
	UL45					—	8377-10C-24	8377-20C-24			
						W	8377-11C-24	8377-21C-24			
Mandibular	Anteriors	-6°	0°	2.5	—	L12	8377-10C-31	8377-20C-31			
	Cuspid	-6°	3°	2.9	—	LL3	8377-10C-33	8377-20C-33			
							W	8377-11C-33	8377-21C-33		
						LR3	0°	—	8377-10C-43	8377-20C-43	
							-6°	W	8377-11C-43	8377-21C-43	
	1st Bicuspid	-12°	2°	2.9	—	LL4	8377-10C-34	8377-20C-34			
							W	8377-11C-34	8377-21C-34		
						LR4	—	8377-10C-44	8377-20C-44		
							W	8377-11C-44	8377-21C-44		
	2nd Bicuspid	-17°	2°	2.9	—	LL5	8377-10C-35	8377-20C-35			
							W	8377-11C-35	8377-21C-35		
						LR5	—	8377-10C-45	8377-20C-45		
							W	8377-11C-45	8377-21C-45		

Bracket Kits	0.018		0.022	
	Upper/Lower 5x5 No Hook	8377-10C		8377-20C
	Upper/Lower 5x5 Hook on 3	8377-13C		8377-23C
	Upper/Lower 5x5 Hook on 3,4,& 5	8377-15C		8377-25C

- Self-ligating Brackets
- Ceramic Brackets
- Lingual Brackets
- Metal Brackets**
- Buccal tubes
- Bands
- Archwires
- Accessories
- Elastomers
- Instruments

DISTINCTION Series MIM Mini Low Profile Roth Brackets

	Tooth	Torq.	Ang.	M/D Width	Hook	L/R	.018 Slot	.022 Slot
Maxillary	Central	12°	5°	3.0	—	UR1	821G-10E-11	821G-20E-11
						UL1	821G-10E-21	821G-20E-21
	Lateral	8°	9°	2.8	—	UR2	821G-10E-12	821G-20E-12
						UL2	821G-10E-22	821G-20E-22
	Cuspid	-2°	11°	2.8	—	UR3	-	821G-20E-13
							W	821G-11E-13
						UL3	-	821G-20E-23
							W	821G-11E-23
	1st & 2nd Bicuspid	-7°	0°	2.8	—	UR45	821G-10E-14	821G-20E-14
							W	821G-11E-14
UL45						821G-10E-24	821G-20E-24	
						W	821G-11E-24	821G-21E-24
Mandibular	Anteriors	-1°	0°	2.4	—	L12	821G-10E-31	821G-20E-31
	Cuspid	-11°	5°	2.8	—	LL3	-	821G-20E-33
							W	821G-11E-33
					LR3	-	821G-20E-43	
						W	821G-11E-43	821G-21E-43
	1st Bicuspid	-17°	0°	2.8	—	LL4	821G-10E-34	821G-20E-34
							W	821G-11E-34
					LR4	821G-10E-44	821G-20E-44	
						W	821G-11E-44	821G-21E-44
	2nd Bicuspid	-22°	0°	2.8	—	LL5	821G-10E-35	821G-20E-35
							W	821G-11E-35
					LR5	821G-10E-45	821G-20E-45	
						W	821G-11E-45	821G-21E-45

Bracket Kits	0.018		0.022	
	Upper/Lower 5x5 No Hook	-	821G-20E	821G-20E
	Upper/Lower 5x5 Hook on 3	821G-13E	821G-23E	821G-23E
	Upper/Lower 5x5 Hook on 3,4,& 5	821G-15E	821G-25E	821G-25E

DISTINCTION Series MIM Mini Low Profile MBT* Brackets

	Tooth	Torq.	Ang.	M/D Width	Hook	L/R	.018 Slot	.022 Slot
Maxillary	Central	17°	4°	3.0	—	UR1	831G-10E-11	831G-20E-11
						UL1	831G-10E-21	831G-20E-21
	Lateral	10°	8°	2.8	—	UR2	831G-10E-12	831G-20E-12
						UL2	831G-10E-22	831G-20E-22
	Cuspid	-7°	8°	2.8	—	UR3	-	831G-20E-13
							W	831G-11E-13
						UL3	-	831G-20E-23
							W	831G-11E-23
	1st & 2nd Bicuspid	-7°	0°	2.8	—	UR45	831G-10E-14	831G-20E-14
							W	831G-11E-14
UL45						831G-10E-24	831G-20E-24	
						W	831G-11E-24	831G-21E-24
Mandibular	Anteriors	-6°	0°	2.4	—	L12	831G-10E-31	831G-20E-31
	Cuspid	-6°	3°	2.8	—	LL3	-	831G-20E-33
							W	831G-11E-33
					LR3	-	831G-20E-43	
						W	831G-11E-43	831G-21E-43
	1st Bicuspid	-12°	2°	2.8	—	LL4	831G-10E-34	831G-20E-34
							W	831G-11E-34
					LR4	831G-10E-44	831G-20E-44	
						W	831G-11E-44	831G-21E-44
	2nd Bicuspid	-17°	2°	2.8	—	LL5	831G-10E-35	831G-20E-35
							W	831G-11E-35
					LR5	831G-10E-45	831G-20E-45	
						W	831G-11E-45	831G-21E-45

Bracket Kits	0.018		0.022	
	Upper/Lower 5x5 No Hook	-	831G-20E	831G-20E
	Upper/Lower 5x5 Hook on 3	831G-13E	831G-23E	831G-23E
	Upper/Lower 5x5 Hook on 3,4,& 5	831G-15E	831G-25E	831G-25E

DISTINCTION Series

One piece



- one-piece 17-4 stainless steel MIM construction, accurate prescription and avoid separation between bracket body and pad;
- Vertical scribe line for accurate placement;
- Number coded for easy bracket selection;
- Micro blasted base providing greater adhesion strength.

- Self-ligating Brackets
- Ceramic Brackets
- Lingual Brackets
- Metal Brackets**
- Buccal tubes
- Bands
- Archwires
- Accessories
- Elastomers
- Instruments

ELITE Series

Mini Roth Brackets

	Tooth	Torq.	Ang.	M/D Width	Hook	L/R	.018 Slot		.022 Slot	
Maxillary	Central	12°	5°	3.1	—	UR1	8215-10H-11	8215-20H-11		
						UL1	8215-10H-21	8215-20H-21		
	Lateral	8°	9°	2.8	—	UR2	8215-10H-12	8215-20H-12		
						UL2	8215-10H-22	8215-20H-22		
	Cuspid	-2°	11°	2.8	—	UR3	8215-10H-13	8215-20H-13		
							W	8215-11H-13	8215-21H-13	
						UL3	8215-10H-23	8215-20H-23		
							W	8215-11H-23	8215-21H-23	
	1st & 2nd Bicuspid	-7°	0°	2.8	—	UR45	8215-10H-14	8215-20H-14		
							W	8215-11H-14	8215-21H-14	
						UL45	8215-10H-24	8215-20H-24		
							W	8215-11H-24	8215-21H-24	
Mandibular	Anteriors	-1°	2°	2.3	—	LL12	8215-10H-31	8215-20H-31		
						LR12	8215-10H-41	8215-20H-41		
	Cuspid	-11°	5°	2.8	—	LL3	8215-10H-33	8215-20H-33		
							W	8215-11H-33	8215-21H-33	
						LR3	8215-10H-43	8215-20H-43		
							W	8215-11H-43	8215-21H-43	
	1st Bicuspid	-17°	0°	2.8	—	LL4	8215-10H-34	8215-20H-34		
							W	8215-11H-34	8215-21H-34	
						LR4	8215-10H-44	8215-20H-44		
							W	8215-11H-44	8215-21H-44	
	2nd Bicuspid	-22°	0°	2.8	—	LL5	8215-10H-35	8215-20H-35		
							W	8215-11H-35	8215-21H-35	
						LR5	8215-10H-45	8215-20H-45		
							W	8215-11H-45	8215-21H-45	

Bracket Kits	0.018		0.022	
	Upper/Lower 5x5 No Hook	8215-10H	8215-20H	
	Upper/Lower 5x5 Hook on 3	8215-13H	8215-23H	
	Upper/Lower 5x5 Hook on 3,4,& 5	8215-15H	8215-25H	

ELITE Series

Mini MBT* Brackets

	Tooth	Torq.	Ang.	M/D Width	Hook	L/R	.018 Slot		.022 Slot	
Maxillary	Central	-17°	4°	3.1	—	UR1	8315-10H-11	8315-20H-11		
						UL1	8315-10H-21	8315-20H-21		
	Lateral	10°	8°	2.8	—	UR2	8315-10H-12	8315-20H-12		
						UL2	8315-10H-22	8315-20H-22		
	Cuspid	-7°	8°	2.8	—	UR3	8315-10H-13	8315-20H-13		
							W	8315-11H-13	8315-21H-13	
						UL3	8315-10H-23	8315-20H-23		
							W	8315-11H-23	8315-21H-23	
	1st & 2nd Bicuspid	-7°	0°	2.8	—	UR45	8315-10H-14	8315-20H-14		
							W	8315-11H-14	8315-21H-14	
						UL45	8315-10H-24	8315-20H-24		
							W	8315-11H-24	8315-21H-24	
Mandibular	Anteriors	-6°	0°	2.3	—	L12	8315-10H-31	8315-20H-31		
						LL3	8315-10H-33	8315-20H-33		
	Cuspid	-6°	3°	2.8	—	LL3	8315-11H-33	8315-21H-33		
							W	8315-10H-43	8315-20H-43	
						LR3	8315-10H-43	8315-20H-43		
							W	8315-11H-43	8315-21H-43	
	1st Bicuspid	-12°	2°	2.8	—	LL4	8315-10H-34	8315-20H-34		
							W	8315-11H-34	8315-21H-34	
						LR4	8315-10H-44	8315-20H-44		
							W	8315-11H-44	8315-21H-44	
	2nd Bicuspid	-17°	2°	2.8	—	LL5	8315-10H-35	8315-20H-35		
							W	8315-11H-35	8315-21H-35	
						LR5	8315-10H-45	8315-20H-45		
							W	8315-11H-45	8315-21H-45	

Bracket Kits	0.018		0.022	
	Upper/Lower 5x5 No Hook	8315-10H	8315-23H	
	Upper/Lower 5x5 Hook on 3	8315-13H	8315-23H	
	Upper/Lower 5x5 Hook on 3,4,& 5	8315-15H	8315-25H	

ELITE Series

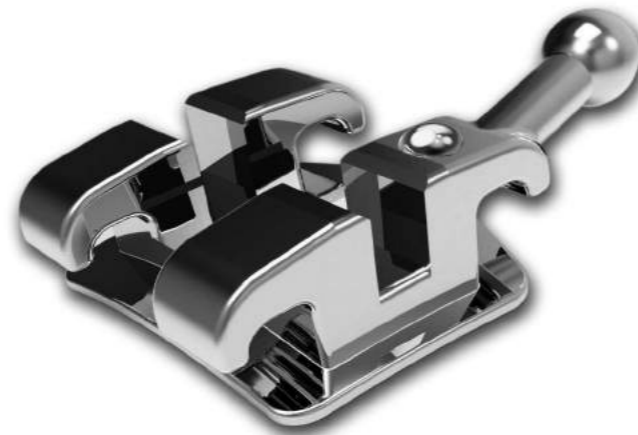

- Ultra fraction slot, CNC milled and finished with advanced polishing process resulting in a perfectly smooth slot ;
- Generous tie wing area for easy bracket ligating;
- Mini low profile, reduces occlusal interference;
- Color enhanced with a removable color coded dot and permanently recessed ID mark;
- Torque in base for level slot lineup.

Self-Ligating Brackets
Ceramic Brackets
Lingual Brackets
Metal Brackets
Buccal Tubes
Bands
Archwires
Accessories
Elastomers
Instruments

E-PLUS Series

Mini Roth Brackets

	Tooth	Torq.	Ang.	M/D Width	Hook	L/R	.018 Slot	.022 Slot
Maxillary	Central	12°	5°	3.1	—	UR1	8215-10K-11	8215-20K-11
						UL1	8215-10K-21	8215-20K-21
	Lateral	8°	9°	2.8	—	UR2	8215-10K-12	8215-20K-12
						UL2	8215-10K-22	8215-20K-22
	Cuspid	-2°	11°	2.8	—	UR3	8215-10K-13	8215-20K-13
							W	8215-11K-13
						UL3	8215-10K-23	8215-20K-23
							W	8215-11K-23
	1st & 2nd Bicuspid	-7°	0°	2.8	—	UR45	8215-10K-14	8215-20K-14
							W	8215-11K-14
						UL45	8215-10K-24	8215-20K-24
							W	8215-11K-24
Mandibular	Anteriors	-1°	0°	2.3	—	L12	8215-10K-31	8215-20K-31
	Cuspid	-11°	5°	2.8	—	LL3	8215-10K-33	8215-20K-33
							W	8215-11K-33
						LR3	8215-10K-43	8215-20K-43
							W	8215-11K-43
	1st Bicuspid	-17°	0°	2.8	—	LL4	8215-10K-34	8215-20K-34
							W	8215-11K-34
						LR4	8215-10K-44	8215-20K-44
							W	8215-11K-44
	2nd Bicuspid	-22°	0°	2.8	—	LL5	8215-10K-35	8215-20K-35
							W	8215-11K-35
						LR5	8215-10K-45	8215-20K-45
							W	8215-11K-45

Bracket Kits	0.018		0.022	
	Upper/Lower 5x5 No Hook	8215-10K	8215-20K	
	Upper/Lower 5x5 Hook on 3	8215-13K	8215-23K	
	Upper/Lower 5x5 Hook on 3,4,& 5	8215-15K	8215-25K	

E-PLUS Series

Mini MBT* Brackets

	Tooth	Torq.	Ang.	M/D Width	Hook	L/R	.018 Slot	.022 Slot
Maxillary	Central	17°	4°	3.1	—	UR1	8315-10K-11	8315-20K-11
						UL1	8315-10K-21	8315-20K-21
	Lateral	10°	8°	2.8	—	UR2	8315-10K-12	8315-20K-12
						UL2	8315-10K-22	8315-20K-22
	Cuspid	-7°	8°	2.8	—	UR3	8315-10K-13	8315-20K-13
							W	8315-11K-13
						UL3	8315-10K-23	8315-20K-23
							W	8315-11K-23
	1st & 2nd Bicuspid	-7°	0°	2.8	—	UR45	8315-10K-14	8315-20K-14
							W	8315-11K-14
						UL45	8315-10K-24	8315-20K-24
							W	8315-11K-24
Mandibular	Anteriors	-6°	0°	2.3	—	L12	8315-10K-31	8315-20K-31
	Cuspid	-6°	3°	2.8	—	LL3	8315-10K-33	8315-20K-33
							W	8315-11K-33
						LR3	8315-10K-43	8315-20K-43
							W	8315-11K-43
	1st Bicuspid	-12°	2°	2.8	—	LL4	8315-10K-34	8315-20K-34
							W	8315-11K-34
						LR4	8315-10K-44	8315-20K-44
							W	8315-11K-44
	2nd Bicuspid	-17°	2°	2.8	—	LL5	8315-10K-35	8315-20K-35
							W	8315-11K-35
						LR5	8315-10K-45	8315-20K-45
							W	8315-11K-45

Bracket Kits	0.018		0.022	
	Upper/Lower 5x5 No Hook	8315-10K	8315-20K	
	Upper/Lower 5x5 Hook on 3	8315-13K	8315-23K	
	Upper/Lower 5x5 Hook on 3,4,& 5	8315-15K	8315-25K	

E-PLUS Series



- Made by Swiss machine with advanced technique;
- Swiss CNC- machined slot ensures the accuracy within±0.02mm;
- Laser welding avoid Loose welding and welding material residues problem compared to traditional welding way, enhanced the welding strength;
- New technique polish leads better surface roughness, maximum patient comfort .

Self-ligating Brackets
Ceramic Brackets
Lingual Brackets
Metal Brackets
Buccal tubes
Bands
Archwires
Accessories
Elastomers
Instruments

Physiological Anchorage Spee's-wire (PASS)



Multi-level Low Friction BRACKETS (M-LF)

The low friction braces with simplest structure
M-LF braces—the only braces in the world to enhance low friction function through saving steels.

	Tooth	Torq.	Ang.	M/D Width	L/R	Item No.
Maxillary	Central	16°	4°	3.0	UR1	8D16-30H-11
					UL1	8D16-30H-21
	Lateral	14°	6°	2.8	UR2	8D16-30H-12
					UL2	8D16-30H-22
	Cuspid	0°	8°	2.8	UR3	8D16-20H-13
					UL3	8D16-20H-23
	1st Bicuspid	-4°	-1°	2.8	UR4	8D16-20H-14
					UL4	8D16-20H-24
	2nd Bicuspid	-4°	-3°	2.8	UR5	8D16-20H-15
					UL5	8D16-20H-25
Mandibular	Anteriors	-3°	0°	2.2	L12	8D16-30H-31
					LL3	8D16-20H-33
	Cuspid	0°	3°	2.8	LR3	8D16-20H-43
					LL4	8D16-20H-34
	1st Bicuspid	-10°	0°	2.8	LR4	8D16-20H-44
					LL5	8D16-20H-35
	2nd Bicuspid	-15°	-2°	2.8	LR5	8D16-20H-45

Bracket Kits	Item Number
Upper/Low er 5x5 No Hook	8D16-40H
Upper/Low er 7x7 No Hook	8D16-40H-A1

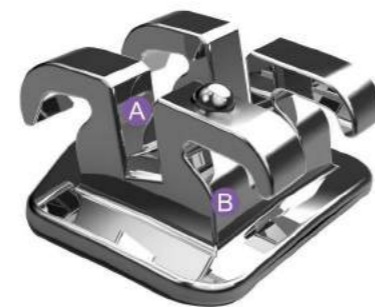

A Dual slot size for better torque control (0.020X0.027for incisors and 0.022X0.027for other teeth)

B Cutting the outer wall of the slot into slope to make a conventional twin bracket into a low friction bracket without changing doctor's ligating habit



Conventional twin bracket



Cutting the outer wall of the slot into slope to reduce the friction between slot and wire by shifting up the ligature wire



M-LF brackets



Gradually increasing tooth control when arch wire and/or ligature wire getting thicker



Full control of tooth when using rectangular wire

XBT Buccal Tubes

XBT buccal tube—the first buccal tube designed with a cross arrangement of a round tube and a rectangular tube. The round tube with -25° makes the molars in a “tip forward position” relative to the arch wire. In most of this situation, the molars take on the most severely mal-positioned teeth and therefor can lead the force system of the arch wire. The rectangular tube with -7° can prevent the molars from tipping forward, which usually happens in extraction cases. Double tip-back buccal tubes provide 24-hour tip-back moments from the thin nickel-titanium (NiTi) wires to thick rectangular wires, thus prevent the loss of physiologic anchorage.

1st Molar XBT Buccal Tubes

Maxillary Non-Convertible Double Buccal Tubes(Rectangular Tube & Round Tube)						
Sys.	Torq.	Distal Offset	Length (mm)	L/R	B-Series	
					.022	
XBT	-10°	10°	4.5	UR	68C5-20E-16	
				UL	68C5-20E-26	

Mandibular Non-Convertible Single Buccal Tubes(Rectangular Tube)						
Sys.	Torq.	Distal Offset	Length (mm)	L/R	B-Series	
					.022	
XBT	-20°	2°	4.8	LR	68B5-20E-36	
				LL	68B5-20E-46	

2nd Molar XBT Buccal Tubes

Maxillary Non-Convertible Single Buccal Tubes(Rectangular Tube)						
Sys.	Torq.	Distal Offset	Length (mm)	L/R	B-Series	
					.022	
XBT	-16°	5°	3.2	UR	68B6-20E-17	
				UL	68B6-20E-27	

Mandibular Non-Convertible Single Buccal Tubes(Rectangular Tube)						
Sys.	Torq.	Distal Offset	Length (mm)	L/R	B-Series	
					.022	
XBT	-20°	0°	3.2	LR	68B6-20E-47	
				LL	68B6-20E-37	

- A** 80 gauge metal mesh keeps the bonding strength.
- B** Special entrance helps guide wire into the buccal tubes.
- C** Color coded indents on the facial surface, assisting bonding and positioning by tweezers or scaler.
- D** -7° rectangular tube
- E** -25° round tube accommodating round wire ≤Φ0.018"

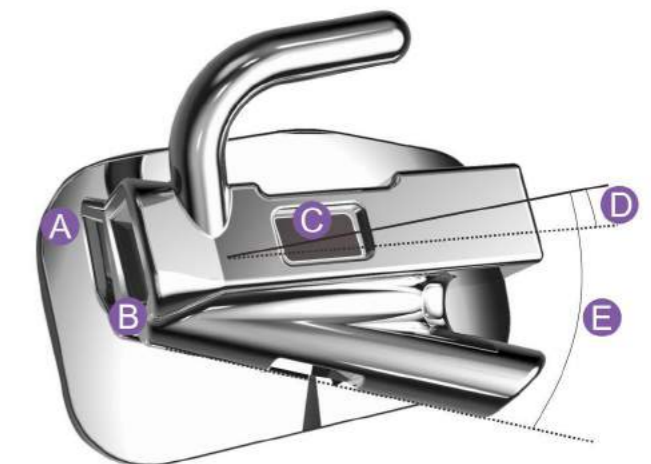

Buccal Tubes

Bondable Buccal Tubes	5.03
1st Molar Buccal Tubes	5.04
Bicuspid Buccal Tubes	5.06
Mini Buccal Tubes	5.06
2nd Molar Buccal Tubes	5.07
Weldable Buccal Tubes	5.08
1st Molar Buccal Tubes	5.09
2nd Molar Buccal Tubes	5.11

BUCCAL TUBES

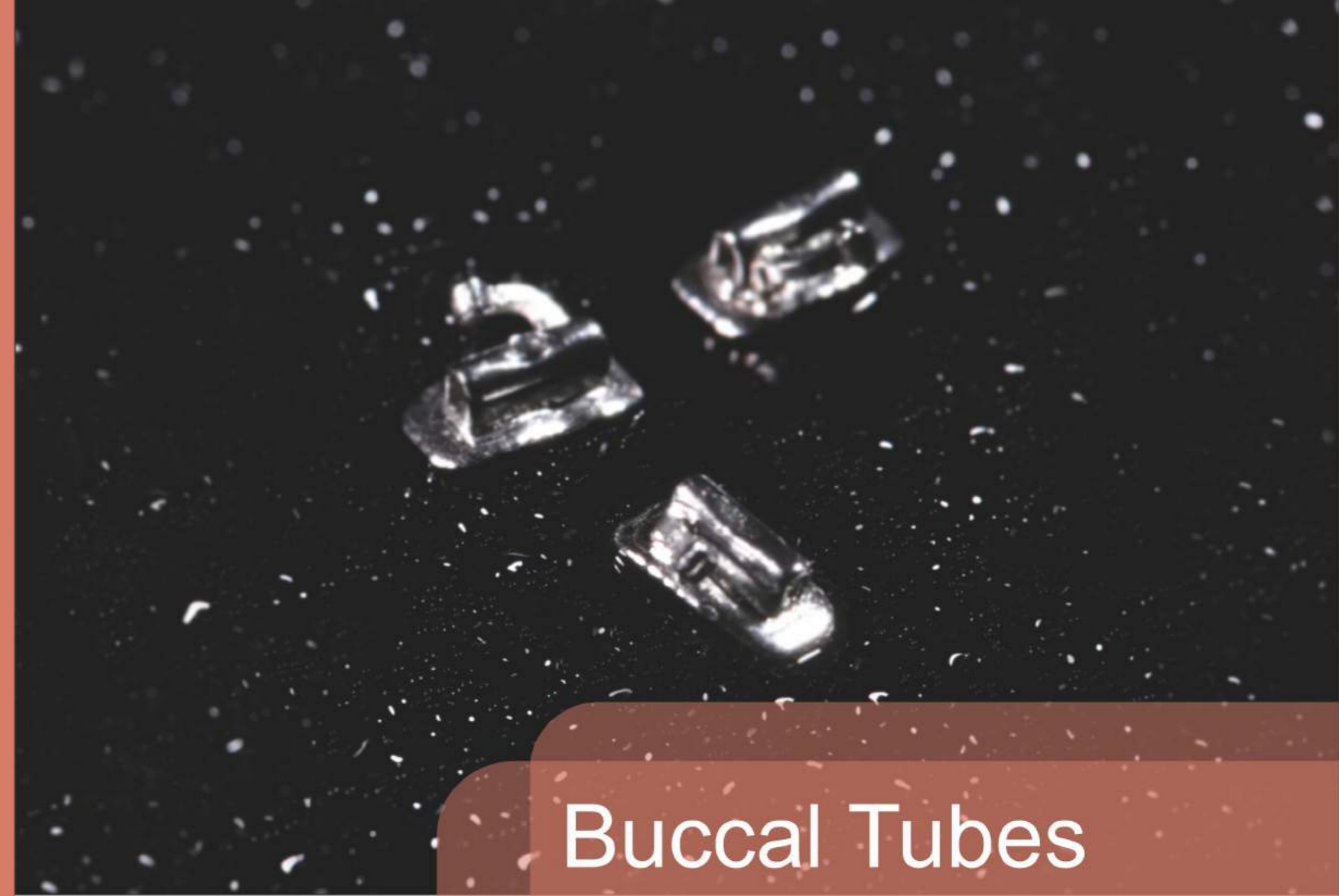

Buccal Tubes

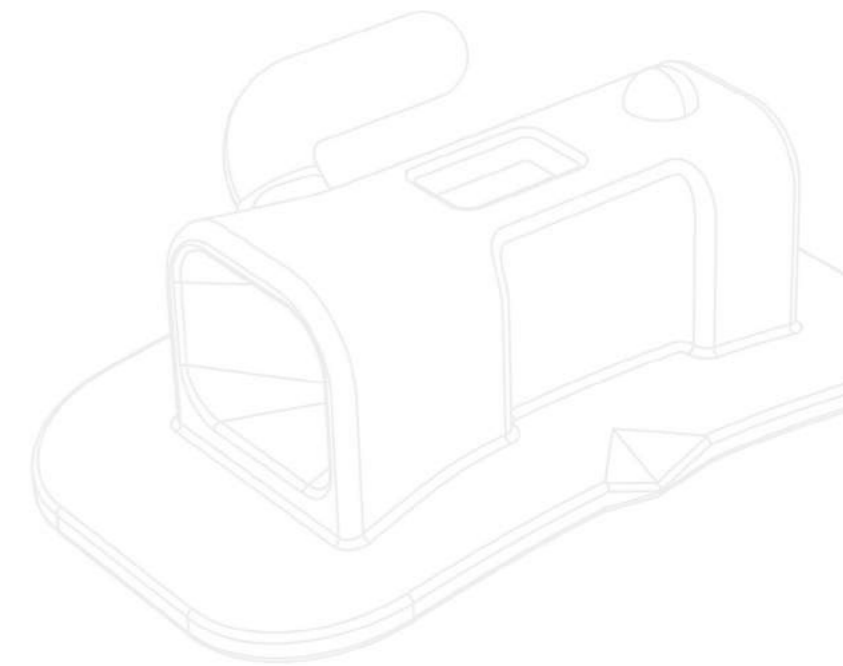

Bondable Buccal Tubes

- 1st Molar Buccal Tubes
- Bicuspid Buccal Tubes
- Mini Buccal Tubes
- 2nd Molar Buccal Tubes



- Low Profile design reduces occlusal interference
- Comfortable hooks for maximum patient comfort
- Anatomically conforms to the teeth

1st Molar Buccal Tubes

10/pk

Maxillary Non-Convertible Single Buccal Tubes(Rectangular Tube)								
Photo	Sys.	Torq.	Distal Offset	Length (mm)	L/R	II		
						.018	.022	
	Edgew ise	0°	0°	4	UR	61BH-10J-16	61BH-20J-16	
					UL	61BH-10J-26	61BH-20J-26	
	Roth	-14°	10°	4	UR	62BH-10J-16	62BH-20J-16	
					UL	62BH-10J-26	62BH-20J-26	
	MBT*	-14°	10°	4	UR	63BH-10J-16	63BH-20J-16	
					UL	63BH-10J-26	63BH-20J-26	

10/pk

Maxillary Non-Convertible Single Buccal Tubes(Rectangular Tube)								
Photo	Sys.	Torq.	Distal Offset	Length (mm)	L/R	IV		
						.022		
	Roth	-14°	10°	4	UR	62BU-20E-16		
					UL	62BU-20E-26		
	MBT*	-14°	10°	4	UR	63BU-20E-16		
					UL	63BU-20E-26		

10/pk

Maxillary Convertible Single Buccal Tubes(Rectangular Tube)								
Photo	Sys.	Torq.	Distal Offset	Length (mm)	L/R	.018	.022	
							Edgew ise	0°
UL	61B7-11B-26	61B7-22J-26						
Roth	-14°	10°	4.1	UR	62B7-12E-16		62B7-22E-16	
				UL	62B7-12E-26		62B7-22E-26	
MBT*	-14°	10°	4.1	UR	63B7-12E-16		63B7-22E-16	
				UL	63B7-12E-26		63B7-22E-26	

10/pk

Maxillary Non-Convertible Double Buccal Tubes(Rectangular Tube & Round Tube)								
Photo	Sys.	Torq.	Distal Offset	Length (mm)	L/R	.018	.022	
							Edgew ise	0°
UL	61C7-10B-26	61C7-20B-26						
Roth	-14°	10°	4.2	UR	62C7-10B-16		62C7-20B-16	
				UL	62C7-10B-26		62C7-20B-26	
MBT*	-14°	10°	4	UR	63C7-10B-16		63C7-20B-16	
				UL	63C7-10B-26		63C7-20B-26	

10/pk

Maxillary Convertible Double Buccal Tubes(Rectangular Tube & Round Tube)								
Photo	Sys.	Torq.	Distal Offset	Length (mm)	L/R	.018	.022	
							Edgew ise	0°
UL	61C7-11B-26	61C7-21B-26						
Roth	-14°	10°	4.2	UR	62C7-11B-16		62C7-21B-16	
				UL	62C7-11B-26		62C7-21B-26	
MBT*	-14°	10°	4	UR	63C7-11B-16		63C7-21B-16	
				UL	63C7-11B-26		63C7-21B-26	

10/pk

Maxillary Convertible Double Buccal Tubes(Double Rectangular Tubes)								
Photo	Sys.	Torq.	Distal Offset	Length (mm)	L/R	.018	.022	
							Edgew ise	0°
UL	61D7-11B-26	61D7-21B-26						
Roth	-14°	10°	4	UR	62D7-12J-16		62D7-22J-16	
				UL	62D7-12J-26		62D7-22J-26	
MBT*	-14°	10°	4	UR	63D7-11B-16		63D7-22J-16	
				UL	63D7-11B-26		63D7-22J-26	

1st Molar Buccal Tubes

10/pk

Maxillary Convertible Tri. Buccal Tubes(Double Rectangular Tubes & Round Tube)							
Photo	Sys.	Torq.	Distal Offset	Length (mm)	L/R	.018	.022
	Edgewise	0°	0°	4	UR	61E7-11B-16	61E7-21B-16
					UL	61E7-11B-26	61E7-21B-26
	Roth	-14°	10°	4	UR	62E7-11B-16	62E7-21B-16
					UL	62E7-11B-26	62E7-21B-26
	MBT*	-14°	10°	4	UR	63E7-11B-16	63E7-21B-16
					UL	63E7-11B-26	63E7-21B-26

10/pk

Mandibular Non-Convertible Single Buccal Tubes(Rectangular Tube)							
Photo	Sys.	Torq.	Distal Offset	Length (mm)	L/R	II	
						.018	.022
	Edgewise	0°	0°	4	LR	61BH-10J-46	61BH-20J-46
					LL	61BH-10J-36	61BH-20J-36
	Roth	-25°	4°	4	LR	62BH-10J-46	62BH-20J-46
					LL	62BH-10J-36	62BH-20J-36
	MBT*	-20°	0°	4	LR	63BH-10J-46	63BH-20J-46
					LL	63BH-10J-36	63BH-20J-36

10/pk

Mandibular Non-Convertible Single Buccal Tubes(Rectangular Tube)							
Photo	Sys.	Torq.	Distal Offset	Length (mm)	L/R	IV 0.022	
							Roth
LL	62BU-20E-36						
MBT*	-20°	0°	4	LR	63BU-20E-46		
				LL	63BU-20E-36		

10/pk

Mandibular Convertible Single Buccal Tubes(Rectangular Tube)							
Photo	Sys.	Torq.	Distal Offset	Length (mm)	L/R	.018	.022
	Edgewise	0°	0°	4	LR	61B7-11B-46	61B7-22J-46
					LL	61B7-11B-36	61B7-22J-36
	Roth	-25°	4°	4.1	LR	62B7-12E-46	62B7-22E-46
					LL	62B7-12E-36	62B7-22E-36
	MBT*	-20°	0°	4.1	LR	63B7-12E-46	63B7-22E-46
					LL	63B7-12E-36	63B7-22E-36

10/pk

Mandibular Convertible Double Buccal Tubes(Double Rectangular Tubes)							
Photo	Sys.	Torq.	Distal Offset	Length (mm)	L/R	.018	.022
	Edgewise	0°	0°	4	LR	61D7-11B-46	61D7-21B-46
					LL	61D7-11B-36	61D7-21B-36
	Roth	-25°	4°	4	LR	62D7-12J-46	62D7-22J-46
					LL	62D7-12J-36	62D7-22J-36
	MBT*	-20°	0°	4	LR	63D7-11B-46	63D7-22J-46
					LL	63D7-11B-36	63D7-22J-36

10/pk

Mandibular Convertible Double Buccal Tubes(Rectangular Tube & Round Tube)							
Photo	Sys.	Torq.	Distal Offset	Length (mm)	L/R	.018	.022
	Edgewise	0°	0°	4	LR	61C7-11B-46	61C7-21B-46
					LL	61C7-11B-36	61C7-21B-36
	Roth	-25°	4°	4.2	LR	62C7-11B-46	62C7-21B-46
					LL	62C7-11B-36	62C7-21B-36
	MBT*	-20°	0°	4	LR	63C7-11B-46	63C7-21B-46
					LL	63C7-11B-36	63C7-21B-36

Bicuspid Buccal Tubes

10/pk

Maxillary Non-Convertible Single Buccal Tubes(Rectangular Tube)							
Photo	Sys.	Torq.	Distal Offset	Length (mm)	L/R	.018	.022
	Roth	-7°	0°	3	UR	—	62B9-20B-15
					UL	—	62B9-20B-25

10/pk

Mandibular Non-Convertible Single Buccal Tubes(Rectangular Tube)							
Photo	Sys.	Torq.	Distal Offset	Length (mm)	L/R	.018	.022
	Roth	-17°	0°	3	LR	—	62B9-20B-45
					LL	—	62B9-20B-35

Mini Buccal Tubes

10/pk

Maxillary Mini Convertible Single Buccal Tubes(Rectangular Tube)							
Photo	Sys.	Torq.	Distal Offset	Length (mm)	L/R	.022	
	Roth	-14°	10°	3	UR	62BC-21E-16	
					UL	62BC-21E-26	

10/pk

Mandibular Mini Convertible Single Buccal Tubes(Rectangular Tube)							
Photo	Sys.	Torq.	Distal Offset	Length (mm)	L/R	.022	
	Roth	-25°	0°	3	LR	62BC-21E-46	
					LL	62BC-21E-36	

10/pk

Maxillary Convertible Double Mini Buccal Tubes(Double Rectangular Tubes)							
Photo	Sys.	Torq.	Distal Offset	Length (mm)	L/R	.022	
	Roth	-14°	10°	3	UR	62DC-22E-16	
					UL	62DC-22E-26	

10/pk

Mandibular Convertible Double Mini Buccal Tubes(Double Rectangular Tubes)							
Photo	Sys.	Torq.	Distal Offset	Length (mm)	L/R	.022	
	Roth	-25°	4°	3	LR	62DC-22E-46	
					LL	62DC-22E-36	

10/pk

Maxillary Mini Non-Convertible Single Buccal Tubes(Rectangular Tube)							
Photo	Sys.	Torq.	Distal Offset	Length (mm)	L/R	.022	
	Roth	-14°	10°	3.4	UR	62BD-20E-17	
					UL	62BD-20E-27	

10/pk

Mandibular Mini Non-Convertible Single Buccal Tubes(Rectangular Tube)							
Photo	Sys.	Torq.	Distal Offset	Length (mm)	L/R	.022	
	Roth	-25°	4°	3.4	LR	62BD-20E-47	
					LL	62BD-20E-37	

Self-ligating Brackets
Ceramic Brackets
Lingual System
Metal Brackets
Buccal tubes
Bands
Archwires
Accessories
Elastomers
Instruments

2nd Molar Buccal Tubes

10/pk

Maxillary Non-Convertible Single Buccal Tubes(Rectangular Tube)									
Photo	Sys.	Torq.	Distal Offset	Length (mm)	L/R	.018	.022	Trumpeted	
								.018	.022
	Edgewise	0°	0°	3.2	UR	61B8-10B-17	61B8-20B-17	61BJ-10E-17	61BJ-20E-17
					UL	61B8-10B-27	61B8-20B-27	61BJ-10E-27	61BJ-20E-27
	Roth	-14°	10°	3.2	UR	62B6-10J-17	62B6-20J-17	62BJ-10E-17	62BJ-20E-17
					UL	62B6-10J-27	62B6-20J-27	62BJ-10E-27	62BJ-20E-27
	MBT*	-14°	10°	3.2	UR	63B8-10B-17	63B8-20E-17	63BJ-10E-17	63BJ-20E-17
					UL	63B8-10B-27	63B8-20E-17	63BJ-10E-27	63BJ-20E-27

10/pk

Mandibular Non-Convertible Single Buccal Tubes(Rectangular Tube)									
Photo	Sys.	Torq.	Distal Offset	Length (mm)	L/R	.018	.022	Trumpeted	
								.018	.022
	Edgewise	0°	0°	3.2	LR	61B8-10B-47	61B8-20B-47	61BJ-10E-47	61BJ-20E-47
					LL	61B8-10B-37	61B8-20B-37	61BJ-10E-37	61BJ-20E-37
	Roth	-25°	4°	3.2	LR	62B6-10J-47	62B6-20J-47	62BJ-10E-47	62BJ-20E-47
					LL	62B6-10J-37	62B6-20J-37	62BJ-10E-37	62BJ-20E-37
	MBT*	-20°	0°	3.2	LR	63B8-10B-47	63B8-20E-47	63BJ-10E-47	63BJ-20E-47
					LL	63B8-10B-37	63B8-20E-37	63BJ-10E-37	63BJ-20E-37

Weldable Buccal Tubes

1st Molar Buccal Tubes
2nd Molar Buccal Tubes



- Buccal Tubes are designed with funneled and radiused entries on both the headgear tubes and archwire slots, while resulting in easy archwire insertion that can reduce patients' chair time.
- Smooth, patient-friendly hooks improve comfort for your patients.
- You'll also appreciate the strong construction, low-profile design and distal notch that secures tie backs.

- Self-ligating Brackets
- Ceramic Brackets
- Lingual System
- Metal Brackets
- Buccal tubes**
- Bands
- Archwires
- Accessories
- Elastomers
- Instruments

1st Molar Buccal Tubes

10/pk

Maxillary Non-Convertible Single Buccal Tubes(Rectangular Tube)							
Photo	Sys.	Torq.	Distal Offset	Length (mm)	L/R	.018	.022
	Edgewise	0°	0°	4	UR	61B1-10B-36	61B1-20F-16
					UL	61B1-10B-46	61B1-20F-26
	Roth	-14°	10°	4	UR	62B1-10B-16	62BQ-20F-16
					UL	62B1-10B-26	62BQ-20F-26
	MBT*	-14°	10°	4	UR	63B1-10B-16	63BQ-20F-16
					UL	63B1-10B-26	63BQ-20F-26

10/pk

Maxillary Convertible Single Buccal Tubes(Rectangular Tube)							
Photo	Sys.	Torq.	Distal Offset	Length (mm)	L/R	.018	.022
	Edgewise	0°	0°	4	UR	61B1-11F-16	61B1-22J-16
					UL	61B1-11F-26	61B1-22J-26
	Roth	-14°	10°	4	UR	62B1-12J-16	62B1-22J-16
					UL	62B1-12J-26	62B1-22J-26
	MBT*	-14°	10°	4	UR	63B1-12J-16	63B1-22J-16
					UL	63B1-12J-26	63B1-22J-26

10/pk

Maxillary Non-Convertible Double Buccal Tubes(Rectangular Tube & Round Tube)							
Photo	Sys.	Torq.	Distal Offset	Length (mm)	L/R	.018	.022
	Edgewise	0°	6°	4	UR	61C1-10F-16	61C1-20F-16
					UL	61C1-10F-26	61C1-20F-26
	Roth	-14°	10°	4	UR	62C1-10F-16	62C1-20F-16
					UL	62C1-10F-26	62C1-20F-26
	MBT*	-14°	10°	4.2	UR	63C1-10B-16	63C1-20B-16
					UL	63C1-10B-26	63C1-20B-26

10/pk

Maxillary Convertible Double Buccal Tubes(Rectangular Tube & Round Tube)							
Photo	Sys.	Torq.	Distal Offset	Length (mm)	L/R	.018	.022
	Edgewise	0°	0°	4	UR	61C1-11F-16	61C1-21F-16
					UL	61C1-11F-26	61C1-21F-26
	Roth	-14°	10°	4	UR	62C1-12J-16	62C1-22J-16
					UL	62C1-12J-26	62C1-22J-26
	MBT*	-14°	10°	4	UR	63C1-12J-16	63C1-22J-16
					UL	63C1-12J-26	63C1-22J-26

10/pk

Maxillary Non-Convertible Double Buccal Tubes(Rectangular Tube & Round Tube) Gingival							
Photo	Sys.	Torq.	Distal Offset	Length (mm)	L/R	.018	.022
	MBT*	-14°	10°	4	UR	-	63C1-20H-16
					UL	-	63C1-20H-26

10/pk

Maxillary Convertible Double Buccal Tubes(Rectangular Tube & Round Tube) Gingival							
Photo	Sys.	Torq.	Distal Offset	Length (mm)	L/R	.018	.022
	Roth	-14°	10°	4	UR	-	62C1-21H-16
					UL	-	62C1-21H-26

1st Molar Buccal Tubes

10/pk

Maxillary Convertible Double Buccal Tubes(Double Rectangular Tubes)							
Photo	Sys.	Torq.	Distal Offset	Length (mm)	L/R	.018	.022
	Edgewise	0°	0°	4	UR	61D1-11B-16	61D1-21B-16
					UL	61D1-11B-26	61D1-21B-26
	Roth	-14°	10°	4	UR	62D1-12J-16	62D1-22J-16
					UL	62D1-12J-26	62D1-22J-26
	MBT*	-14°	10°	4	UR	63D1-12J-16	63D1-22J-16
					UL	63D1-12J-26	63D1-22J-26

10/pk

Maxillary Convertible Tri. Buccal Tubes(Double Rectangular Tubes & Round Tube)							
Photo	Sys.	Torq.	Distal Offset	Length (mm)	L/R	.018	.022
	Edgewise	0°	0°	4	UR	61E1-11B-16	61E1-21B-16
					UL	61E1-11B-26	61E1-21B-26
	Roth	-14°	10°	4	UR	62E1-12J-16	62E1-22J-16
					UL	62E1-12J-26	62E1-22J-26
	MBT*	-14°	10°	4	UR	63E1-11F-16	63E1-22J-16
					UL	63E1-11F-26	63E1-22J-26

10/pk

Mandibular Non-Convertible Single Buccal Tubes(Rectangular Tube)							
Photo	Sys.	Torq.	Distal Offset	Length (mm)	L/R	.018	.022
	Edgewise	0°	0°	4	LR	61B1-10B-46	61B1-20F-46
					LL	61B1-10B-36	61B1-20F-36
	Roth	-25°	4°	4	LR	62B1-10F-46	62BQ-20F-46
					LL	62B1-10F-36	62BQ-20F-36
	MBT*	-20°	0°	4	LR	-	63BQ-20F-46
					LL	-	63BQ-20F-36

10/pk

Mandibular Convertible Single Buccal Tubes(Rectangular Tube)							
Photo	Sys.	Torq.	Distal Offset	Length (mm)	L/R	.018	.022
	Edgewise	0°	0°	4	LR	61B1-11F-46	61B1-22J-46
					LL	61B1-11F-36	61B1-22J-36
	Roth	-25°	4°	4	LR	62B1-12J-46	62B1-22J-46
					LL	62B1-12J-36	62B1-22J-36
	MBT*	-20°	0°	4	LR	63B1-12J-46	63B1-22J-46
					LL	63B1-12J-36	63B1-22J-36

10/pk

Mandibular Convertible Double Buccal Tubes(Double Rectangular Tubes)							
Photo	Sys.	Torq.	Distal Offset	Length (mm)	L/R	.018	.022
	Edgewise	0°	0°	4	LR	61D1-11B-46	61D1-21B-46
					LL	61D1-11B-36	61D1-21B-36
	Roth	-25°	4°	4	LR	62D1-12J-46	62D1-22J-46
					LL	62D1-12J-36	62D1-22J-36
	MBT*	-25°	4°	4.2	LR	63D1-12J-46	63D1-22J-46
					LL	63D1-12J-36	63D1-22J-36

10/pk

Mandibular Convertible Double Buccal Tubes(Rectangular Tube & Round Tube)							
Photo	Sys.	Torq.	Distal Offset	Length (mm)	L/R	.018	.022
	Edgewise	0°	0°	4	LR	61C1-11B-46	61C1-21B-46
					LL	61C1-11B-36	61C1-21B-36
	Roth	-14°	10°	4	LR	62C1-12J-16	62C1-22J-16
					LL	62C1-12J-26	62C1-22J-26
	MBT*	-20°	0°	4	LR	63C1-12J-46	63C1-22J-46
					LL	63C1-12J-36	63C1-22J-36

Self-ligating Brackets
Ceramic Brackets
Lingual System
Metal Brackets
Buccal tubes
Bands
Archwires
Accessories
Elastomers
Instruments

Step 1. Select Band

Step 2. Select Buccal Tube

	Single	Double	Triple
Non-Convertible			
Convertible			

Step 3. Add Attachments

	Lingual Buttons	Lingual Cleats	Seating Lugs
Lingual Attachments			
Lingual Sheaths			



Bands



- Permanent laser ID marking
- Straight interproximal walls for reduced separation
- Reduced gingival/occlusal dimensions for less occlusal and gingival interferences
- Available with micro-etched inner surface for increased retention
- Curved festooned occlusal interproximal walls
- Increased occlusal “Edge” strength for reduced deformation
- E-Inner Rough

Bicuspid Bands

10/pk

Size	Perimeter (mm)	Item No.	Perimeter (mm)	Item No.	Perimeter (mm)	Item No.
Upper			Lower 1st		Lower 2nd	
1	21.7	E 5A01-000-U1	19.5	E 5A01-000-L1		
2	22	E 5A01-000-U2	19.84	E 5A01-000-L2		
3	22.3	E 5A01-000-U3	20.18	E 5A01-000-L3		
4	22.6	E 5A01-000-U4	20.52	E 5A01-000-L4		
5	22.9	E 5A01-000-U5	20.86	E 5A01-000-L5		
6	23.2	E 5A01-000-U6	21.2	E 5A01-000-L6		
7	23.5	E 5A01-000-U7	21.54	E 5A01-000-L7		
8	23.8	E 5A01-000-U8	21.88	E 5A01-000-L8		
9	24.1	E 5A01-000-U9	22.22	E 5A01-000-L9		
10	24.4	E 5A01-000-U10	22.56	E 5A01-000-L10		
11	24.7	E 5A01-000-U11	22.9	E 5A01-000-L11	22.8	E 5A02-000-11L
12	25	E 5A01-000-U12	23.24	E 5A01-000-L12	23.14	E 5A02-000-12L
13	25.3	E 5A01-000-U13	23.58	E 5A01-000-L13	23.48	E 5A02-000-13L
14	25.6	E 5A01-000-U14	23.92	E 5A01-000-L14	23.82	E 5A02-000-14L
15	25.9	E 5A01-000-U15	24.26	E 5A01-000-L15	24.16	E 5A02-000-15L
16	26.2	E 5A01-000-U16	24.6	E 5A01-000-L16	24.5	E 5A02-000-16L
17	26.5	E 5A01-000-U17	24.94	E 5A01-000-L17	24.84	E 5A02-000-17L
18	26.8	E 5A01-000-U18			25.18	E 5A02-000-18L
19	27.1	E 5A01-000-U19			25.52	E 5A02-000-19L
20	27.4	E 5A01-000-U20			25.86	E 5A02-000-20L
21	27.7	E 5A01-000-U21			26.2	E 5A02-000-21L
22	28	E 5A01-000-U22			26.54	E 5A02-000-22L
23	28.3	E 5A01-000-U23			26.88	E 5A02-000-23L
24	28.6	E 5A01-000-U24			27.22	E 5A02-000-24L
25	28.9	E 5A01-000-U25			27.56	E 5A02-000-25L
26	29.2	E 5A01-000-U26			27.9	E 5A02-000-26L
27	29.5	E 5A01-000-U27			28.24	E 5A02-000-27L
28	29.8	E 5A01-000-U28			28.58	E 5A02-000-28L
29	30.1	E 5A01-000-U29			28.92	E 5A02-000-29L
30	30.4	E 5A01-000-U30			29.26	E 5A02-000-30L
31	30.7	E 5A01-000-U31			29.6	E 5A02-000-31L
32	31	E 5A01-000-U32			29.94	E 5A02-000-32L

1st Molar Bands M Size

10/pk

Size	Perimeter (mm)	Item No.			
		UR	UL	LL	LR
28	28	E 5003 - 000 - 128	E 5003 - 000 - 228	E 5003 - 000 - 328	E 5003 - 000 - 428
28+	28.5	E 5003 - 000 - 128+	E 5003 - 000 - 228+	E 5003 - 000 - 328+	E 5003 - 000 - 428+
29	29	E 5003 - 000 - 129	E 5003 - 000 - 229	E 5003 - 000 - 329	E 5003 - 000 - 429
29+	29.5	E 5003 - 000 - 129+	E 5003 - 000 - 229+	E 5003 - 000 - 329+	E 5003 - 000 - 429+
30	30	E 5003 - 000 - 130	E 5003 - 000 - 230	E 5003 - 000 - 330	E 5003 - 000 - 430
30+	30.5	E 5003 - 000 - 130+	E 5003 - 000 - 230+	E 5003 - 000 - 330+	E 5003 - 000 - 430+
31	31	E 5003 - 000 - 131	E 5003 - 000 - 231	E 5003 - 000 - 331	E 5003 - 000 - 431
31+	31.5	E 5003 - 000 - 131+	E 5003 - 000 - 231+	E 5003 - 000 - 331+	E 5003 - 000 - 431+
32	32	E 5003 - 000 - 132	E 5003 - 000 - 232	E 5003 - 000 - 332	E 5003 - 000 - 432
32+	32.5	E 5003 - 000 - 132+	E 5003 - 000 - 232+	E 5003 - 000 - 332+	E 5003 - 000 - 432+
33	33	E 5003 - 000 - 133	E 5003 - 000 - 233	E 5003 - 000 - 333	E 5003 - 000 - 433
33+	33.5	E 5003 - 000 - 133+	E 5003 - 000 - 233+	E 5003 - 000 - 333+	E 5003 - 000 - 433+
34	34	E 5003 - 000 - 134	E 5003 - 000 - 234	E 5003 - 000 - 334	E 5003 - 000 - 434
34+	34.5	E 5003 - 000 - 134+	E 5003 - 000 - 234+	E 5003 - 000 - 334+	E 5003 - 000 - 434+
35	35	E 5003 - 000 - 135	E 5003 - 000 - 235	E 5003 - 000 - 335	E 5003 - 000 - 435
35+	35.5	E 5003 - 000 - 135+	E 5003 - 000 - 235+	E 5003 - 000 - 335+	E 5003 - 000 - 435+
36	36	E 5003 - 000 - 136	E 5003 - 000 - 236	E 5003 - 000 - 336	E 5003 - 000 - 436
36+	36.5	E 5003 - 000 - 136+	E 5003 - 000 - 236+	E 5003 - 000 - 336+	E 5003 - 000 - 436+
37	37	E 5003 - 000 - 137	E 5003 - 000 - 237	E 5003 - 000 - 337	E 5003 - 000 - 437
37+	37.5	E 5003 - 000 - 137+	E 5003 - 000 - 237+	E 5003 - 000 - 337+	E 5003 - 000 - 437+
38	38	E 5003 - 000 - 138	E 5003 - 000 - 238	E 5003 - 000 - 338	E 5003 - 000 - 438
38+	38.5	E 5003 - 000 - 138+	E 5003 - 000 - 238+	E 5003 - 000 - 338+	E 5003 - 000 - 438+
39	39	E 5003 - 000 - 139	E 5003 - 000 - 239	E 5003 - 000 - 339	E 5003 - 000 - 439
39+	39.5	E 5003 - 000 - 139+	E 5003 - 000 - 239+	E 5003 - 000 - 339+	E 5003 - 000 - 439+
40	40	E 5003 - 000 - 140	E 5003 - 000 - 240	E 5003 - 000 - 340	E 5003 - 000 - 440
40+	40.5	E 5003 - 000 - 140+	E 5003 - 000 - 240+	E 5003 - 000 - 340+	E 5003 - 000 - 440+
41	41	E 5003 - 000 - 141	E 5003 - 000 - 241	E 5003 - 000 - 341	E 5003 - 000 - 441
41+	41.5	E 5003 - 000 - 141+	E 5003 - 000 - 241+	E 5003 - 000 - 341+	E 5003 - 000 - 441+
42	42	E 5003 - 000 - 142	E 5003 - 000 - 242	E 5003 - 000 - 342	E 5003 - 000 - 442
42+	42.5	E 5003 - 000 - 142+	E 5003 - 000 - 242+	E 5003 - 000 - 342+	E 5003 - 000 - 442+
43	43	E 5003 - 000 - 143	E 5003 - 000 - 243	E 5003 - 000 - 343	E 5003 - 000 - 443
43+	43.5	E 5003 - 000 - 143+	E 5003 - 000 - 243+	E 5003 - 000 - 343+	E 5003 - 000 - 443+
44	44	E 5003 - 000 - 144	E 5003 - 000 - 244	E 5003 - 000 - 344	E 5003 - 000 - 444
44+	44+	E 5003 - 000 - 144+	E 5003 - 000 - 244+	E 5003 - 000 - 344+	E 5003 - 000 - 444+

Self-ligating Brackets
Ceramic Brackets
Lingual System
Metal Brackets
Buccal Tubes
Bands
Archwires
Accessories
Elastomers
Instruments

1st Molar Bands O Size

10/pk

Size	Perimeter (mm)	Item No.			
		UR	UL	LL	LR
5	30	E 5005-000 - 105	E 5005-000 - 205	E 5005-000 - 305	E 5005-000 - 405
6	30.5	E 5005-000 - 106	E 5005-000 - 206	E 5005-000 - 306	E 5005-000 - 406
7	31	E 5005-000 - 107	E 5005-000 - 207	E 5005-000 - 307	E 5005-000 - 407
8	31.5	E 5005-000 - 108	E 5005-000 - 208	E 5005-000 - 308	E 5005-000 - 408
9	32	E 5005-000 - 109	E 5005-000 - 209	E 5005-000 - 309	E 5005-000 - 409
10	32.5	E 5005-000 - 110	E 5005-000 - 210	E 5005-000 - 310	E 5005-000 - 410
11	33	E 5005-000 - 111	E 5005-000 - 211	E 5005-000 - 311	E 5005-000 - 411
12	33.5	E 5005-000 - 112	E 5005-000 - 212	E 5005-000 - 312	E 5005-000 - 412
13	34	E 5005-000 - 113	E 5005-000 - 213	E 5005-000 - 313	E 5005-000 - 413
14	34.5	E 5005-000 - 114	E 5005-000 - 214	E 5005-000 - 314	E 5005-000 - 414
15	35	E 5005-000 - 115	E 5005-000 - 215	E 5005-000 - 315	E 5005-000 - 415
16	35.5	E 5005-000 - 116	E 5005-000 - 216	E 5005-000 - 316	E 5005-000 - 416
17	36	E 5005-000 - 117	E 5005-000 - 217	E 5005-000 - 317	E 5005-000 - 417
18	36.5	E 5005-000 - 118	E 5005-000 - 218	E 5005-000 - 318	E 5005-000 - 418
19	37	E 5005-000 - 119	E 5005-000 - 219	E 5005-000 - 319	E 5005-000 - 419
20	37.5	E 5005-000 - 120	E 5005-000 - 220	E 5005-000 - 320	E 5005-000 - 420
21	38	E 5005-000 - 121	E 5005-000 - 221	E 5005-000 - 321	E 5005-000 - 421
22	38.5	E 5005-000 - 122	E 5005-000 - 222	E 5005-000 - 322	E 5005-000 - 422
23	39	E 5005-000 - 123	E 5005-000 - 223	E 5005-000 - 323	E 5005-000 - 423
24	39.5	E 5005-000 - 124	E 5005-000 - 224	E 5005-000 - 324	E 5005-000 - 424
25	40	E 5005-000 - 125	E 5005-000 - 225	E 5005-000 - 325	E 5005-000 - 425
26	40.5	E 5005-000 - 126	E 5005-000 - 226	E 5005-000 - 326	E 5005-000 - 426
27	41	E 5005-000 - 127	E 5005-000 - 227	E 5005-000 - 327	E 5005-000 - 427
28	41.5	E 5005-000 - 128	E 5005-000 - 228	E 5005-000 - 328	E 5005-000 - 428
29	42	E 5005-000 - 129	E 5005-000 - 229	E 5005-000 - 329	E 5005-000 - 429
30	42.5	E 5005-000 - 130	E 5005-000 - 230	E 5005-000 - 330	E 5005-000 - 430
31	43	E 5005-000 - 131	E 5005-000 - 231	E 5005-000 - 331	E 5005-000 - 431
32	43.5	E 5005-000 - 132	E 5005-000 - 232	E 5005-000 - 332	E 5005-000 - 432
33	44	E 5005-000 - 133	E 5005-000 - 233	E 5005-000 - 333	E 5005-000 - 433
34	44.5	E 5005-000 - 134	E 5005-000 - 234	E 5005-000 - 334	E 5005-000 - 434
35	45	E 5005-000 - 135	E 5005-000 - 235	E 5005-000 - 335	E 5005-000 - 435
36	45.5	E 5005-000 - 136	E 5005-000 - 236	E 5005-000 - 336	E 5005-000 - 436

2nd Molar Bands M Size

10/pk

Size	Perimeter (mm)	Item No.			
		UR	UL	LL	LR
28	28	E 5004-000-128	E 5004-000-228	E 5004-000-328	E 5004-000-428
28+	28.5	E 5004-000-128+	E 5004-000-228+	E 5004-000-328+	E 5004-000-428+
29	29	E 5004 - 000 - 129	E 5004 - 000 - 229	E 5004 - 000 - 329	E 5004 - 000 - 429
29+	29.5	E 5004 - 000 - 129+	E 5004 - 000 - 229+	E 5004 - 000 - 329+	E 5004 - 000 - 429+
30	30	E 5004 - 000 - 130	E 5004 - 000 - 230	E 5004 - 000 - 330	E 5004 - 000 - 430
30+	30.5	E 5004 - 000 - 130+	E 5004 - 000 - 230+	E 5004 - 000 - 330+	E 5004 - 000 - 430+
31	31	E 5004 - 000 - 131	E 5004 - 000 - 231	E 5004 - 000 - 331	E 5004 - 000 - 431
31+	31.5	E 5004 - 000 - 131+	E 5004 - 000 - 231+	E 5004 - 000 - 331+	E 5004 - 000 - 431+
32	32	E 5004 - 000 - 132	E 5004 - 000 - 232	E 5004 - 000 - 332	E 5004 - 000 - 432
32+	32.5	E 5004 - 000 - 132+	E 5004 - 000 - 232+	E 5004 - 000 - 332+	E 5004 - 000 - 432+
33	33	E 5004 - 000 - 133	E 5004 - 000 - 233	E 5004 - 000 - 333	E 5004 - 000 - 433
33+	33.5	E 5004 - 000 - 133+	E 5004 - 000 - 233+	E 5004 - 000 - 333+	E 5004 - 000 - 433+
34	34	E 5004 - 000 - 134	E 5004 - 000 - 234	E 5004 - 000 - 334	E 5004 - 000 - 434
34+	34.5	E 5004 - 000 - 134+	E 5004 - 000 - 234+	E 5004 - 000 - 334+	E 5004 - 000 - 434+
35	35	E 5004 - 000 - 135	E 5004 - 000 - 235	E 5004 - 000 - 335	E 5004 - 000 - 435
35+	35.5	E 5004 - 000 - 135+	E 5004 - 000 - 235+	E 5004 - 000 - 335+	E 5004 - 000 - 435+
36	36	E 5004 - 000 - 136	E 5004 - 000 - 236	E 5004 - 000 - 336	E 5004 - 000 - 436
36+	36.5	E 5004 - 000 - 136+	E 5004 - 000 - 236+	E 5004 - 000 - 336+	E 5004 - 000 - 436+
37	37	E 5004 - 000 - 137	E 5004 - 000 - 237	E 5004 - 000 - 337	E 5004 - 000 - 437
37+	37.5	E 5004 - 000 - 137+	E 5004 - 000 - 237+	E 5004 - 000 - 337+	E 5004 - 000 - 437+
38	38	E 5004 - 000 - 138	E 5004 - 000 - 238	E 5004 - 000 - 338	E 5004 - 000 - 438
38+	38.5	E 5004 - 000 - 138+	E 5004 - 000 - 238+	E 5004 - 000 - 338+	E 5004 - 000 - 438+
39	39	E 5004 - 000 - 139	E 5004 - 000 - 239	E 5004 - 000 - 339	E 5004 - 000 - 439
39+	39.5	E 5004 - 000 - 139+	E 5004 - 000 - 239+	E 5004 - 000 - 339+	E 5004 - 000 - 439+
40	40	E 5004 - 000 - 140	E 5004 - 000 - 240	E 5004 - 000 - 340	E 5004 - 000 - 440
40+	40.5	E 5004 - 000 - 140+	E 5004 - 000 - 240+	E 5004 - 000 - 340+	E 5004 - 000 - 440+
41	41	E 5004 - 000 - 141	E 5004 - 000 - 241	E 5004 - 000 - 341	E 5004 - 000 - 441
41+	41.5	E 5004 - 000 - 141+	E 5004 - 000 - 241+	E 5004 - 000 - 342	E 5004 - 000 - 441+
42	42	E 5004 - 000 - 142	E 5004 - 000 - 242	E 5004 - 000 - 343	E 5004 - 000 - 442

- Self-ligating Brackets
- Ceramic Brackets
- Lingual System
- Metal Brackets
- Buccal Tubes
- Bands
- Archwires
- Accessories
- Elastomers
- Instruments

Archwires

Stainless Steel Archwires	7.03
Stainless Steel Straight Lengths	7.05
Ligature Wires	7.05
NiTi open Coil Springs	7.06
Preformed Ligature	7.06
Kobayashi Ties	7.06
Nickel Titanium Archwire	7.07
NiTi Super-Elastic Archwire	7.09
NiTi Heat Activated Archwire	7.10
NiTi Reverse Curve Of Spee	7.10

ARCHWIRES



Archwires



Stainless Steel Archwire Arch Forms

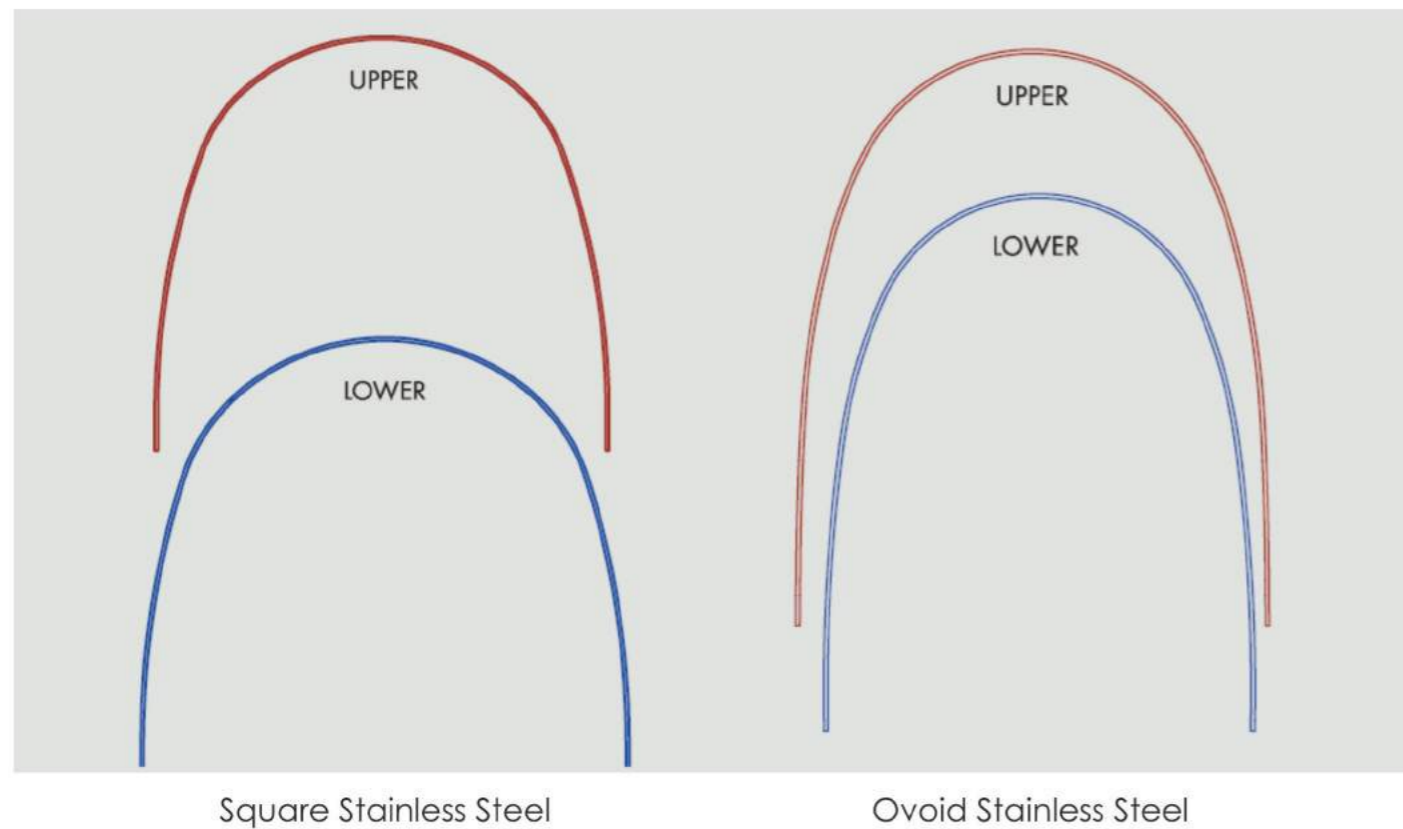
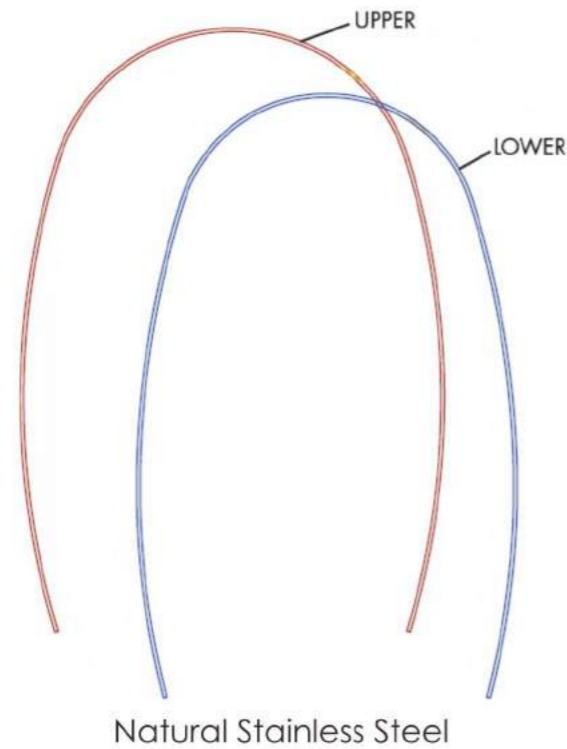

Stainless Steel Archwires

Stainless Steel Archwires made from the highest quality 304V vacuum Arc Remented (VAR), combine superior strength and stiffness with advanced flexibility, allowing them to accept bends without breaking.

	Size	Square		Ovoid		Nature		10/pk
		Upper	Lower	Upper	Lower	Upper	Lower	
		Round	0.012"	3611-0012	3621-0012	3612-0012	3622-0012	
0.014"	3611-0014	3621-0014	3612-0014	3622-0014	3613-0014	3623-0014		
0.016"	3611-0016	3621-0016	3612-0016	3622-0016	3613-0016	3623-0016		
0.018"	3611-0018	3621-0018	3612-0018	3622-0018	3613-0018	3623-0018		
0.020"	3611-0020	3621-0020	3612-0020	3622-0020	3613-0020	3623-0020		
Rectangular	0.016"×0.016"	3511-1616	3521-1616	3512-1616	3522-1616	3513-1616	3523-1616	
	0.016"×0.022"	3511-1622	3521-1622	3512-1622	3522-1622	3513-1622	3523-1622	
	0.016"×0.025"	3511-1625	3521-1625	3512-1625	3522-1625	3513-1625	3523-1625	
	0.017"×0.017"	3511-1717	3521-1717	3512-1717	3522-1717	3513-1717	3523-1717	
	0.017"×0.025"	3511-1725	3521-1725	3512-1725	3522-1725	3513-1725	3523-1725	
	0.018"×0.018"	3511-1818	3521-1818	3512-1818	3522-1818	3513-1818	3523-1818	
	0.018"×0.025"	3511-1825	3521-1825	3512-1825	3522-1825	3513-1825	3523-1825	
	0.019"×0.025"	3511-1925	3521-1925	3512-1925	3522-1925	3513-1925	3523-1925	
	0.020"×0.020"	3511-2020	3521-2020	3512-2020	3522-2020	3513-2020	3523-2020	
	0.021"×0.025"	3511-2125	3521-2125	3512-2125	3522-2125	3513-2125	3523-2125	
0.021"×0.028"	3511-2128	3521-2128	3512-2128	3522-2128	3513-2128	3523-2128		

- Self-ligating Brackets
- Ceramic Brackets
- Lingual System
- Metal Brackets
- Buccal Tubes
- Bands
- Archwires
- Accessories
- Elastomers
- Instruments

Stainless Steel Straight Lengths

Stainless Steel Straight Lengths combine superior straight and stiffness with excellent flexibility—perfect for your custom wire-forming needs. Made from quality 304V vacuum Arch Remelted (VAR) stainless Steel, this alloy is very easy to work with and will accept loops and bends without breaking.

10/pk

Size	Item Number
0.012"	3636-0012
0.014"	3636-0014
0.016"	3636-0016
0.018"	3636-0018
0.020"	3636-0020

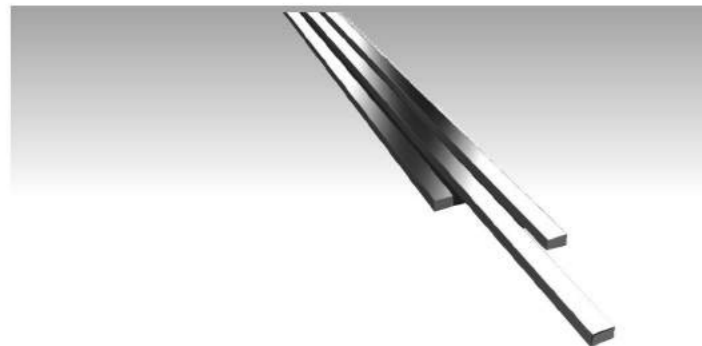
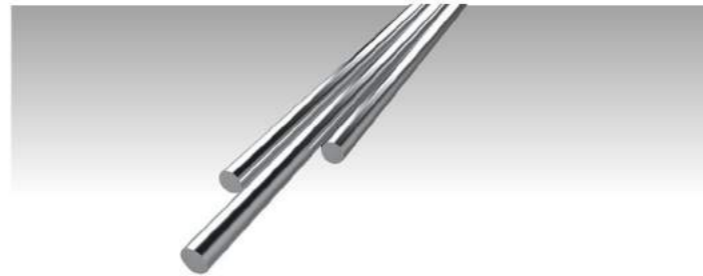

10/pk

Size	Item Number
0.016"×0.016"	3536-1616
0.016"×0.022"	3536-1622
0.017"×0.025"	3536-1725
0.018"×0.018"	3536-1818
0.018"×0.025"	3536-1825
0.019"×0.025"	3536-1925
0.020"×0.020"	3536-2020
0.021"×0.025"	3536-2125

Ligature Wires 50g/pk

Size	Item Number
0.009	3650-0020
0.010	3650-0025
0.012	3650-0030
0.014	3650-0035



NiTi open Coil Springs

2/pk

Size	Item Number
0.008"	3147-0008
0.010"	3147-0010
0.012"	3147-0012



Preformed Ligature

100/pk

Size		Item Number
0.010	Short	3651-0025
0.009	Long	3653-0020
0.010	Long	3653-0025
0.012	Long	3653-0030

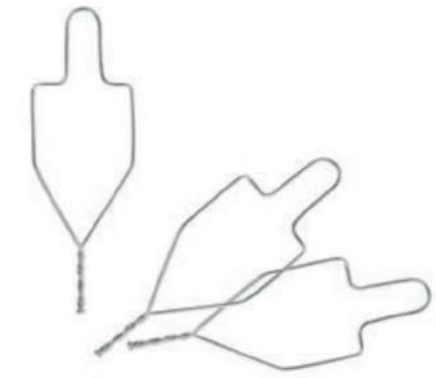

Kobayashi Ties

100/pk

Size		Item Number
0.012	Short	3652-0030
0.014	Short	3652-0035
0.012	Long	3654-0030
0.014	Long	3654-0035

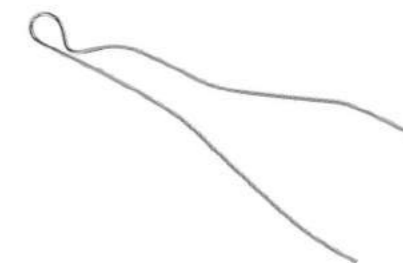
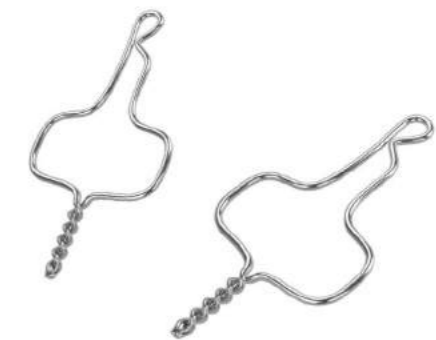

NiTi Arch Forms

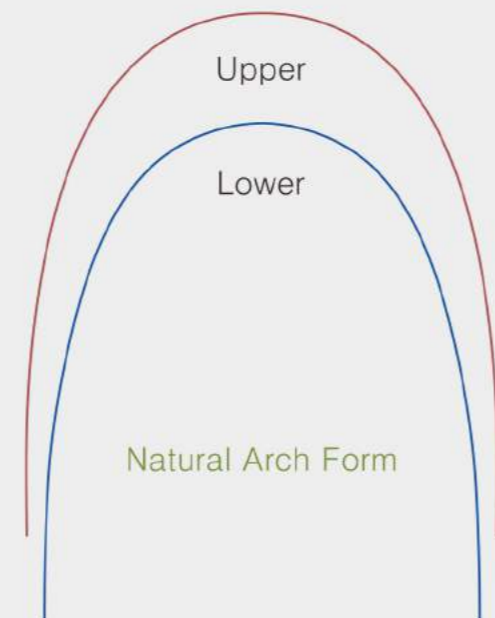
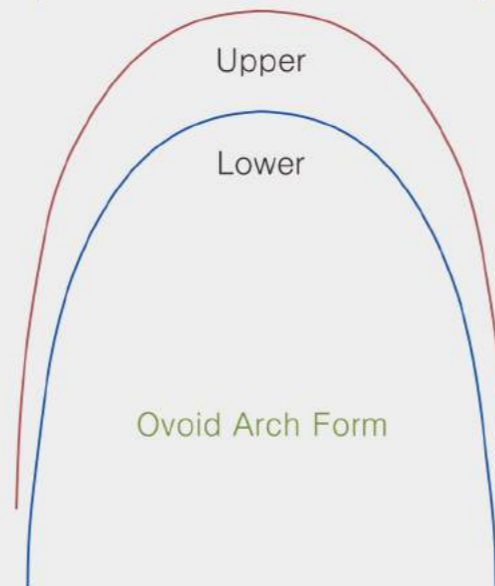
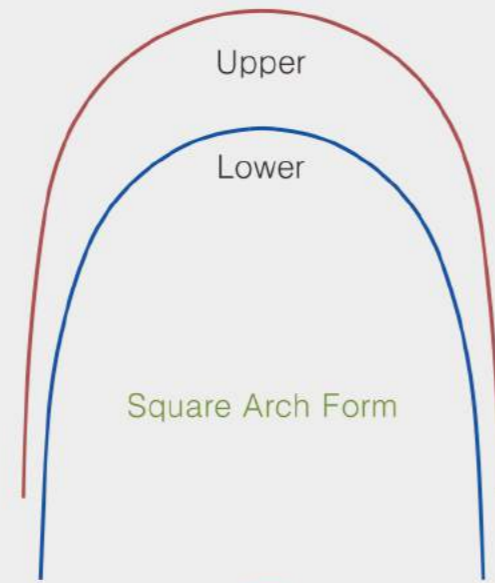

Nickel Titanium Archwire

Niti alloy is one shape memory alloy that ratio of expansion and contraction can reach much more than 20%, fatigue life can reach seventh power of 1×10^7 , the damping characteristic is higher 10 multiple than normal spring, corrosion resistance is better than the best medical stainless steel. It can meet all kinds of engineering and medical needs that is one perfect functional material. Excepting particular shape memory function, Niti alloy possesses anti abrasive, corrosion resistant, high damping characteristic and super-elastic features.

The Main Features:

- .Higher lustrousness which adopts Germany equipment to polish
- .More smooth surface that reduces friction with brackets
- .Remarkable curative effect in treating open bite, cross bite, torsion and crowding teeth.

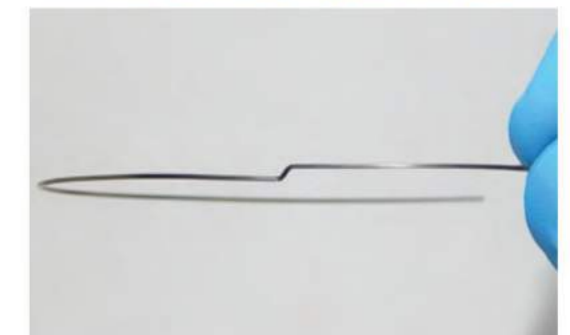
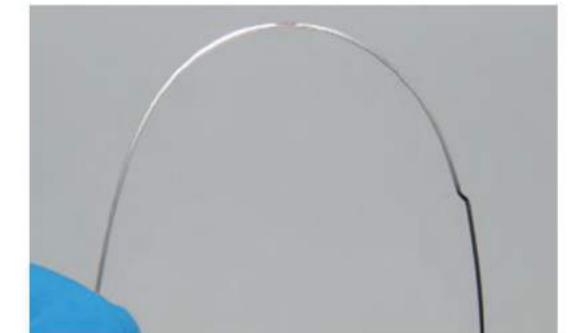

NiTi Super-Elastic Archwire

- Great to open deep bite cases and control arch levelness during canine retraction.
- 3-Dimensional control of teeth movement to counteract the side effect of closing chain "with regular NiTi".
- Available in round and rectangular sizes, regular and straight leg shapes

10/pk

	Size	Square		Ovoid		Nature	
		Upper	Lower	Upper	Lower	Upper	Lower
		Round					
0.010"		3111-0010	3121-0010	3112-0010	3122-0010	3113-0010	3123-0010
0.012"		3111-0012	3121-0012	3112-0012	3122-0012	3113-0012	3123-0012
0.014"		3111-0014	3121-0014	3112-0014	3122-0014	3113-0014	3123-0014
0.016"		3111-0016	3121-0016	3112-0016	3122-0016	3113-0016	3123-0016
0.018"		3111-0018	3121-0018	3112-0018	3122-0018	3113-0018	3123-0018
0.020"		3111-0020	3121-0020	3112-0020	3122-0020	3113-0020	3123-0020
Rectangular							
0.016"x0.016"		3111-1616	3121-1616	3112-1616	3122-1616	3113-1616	3123-1616
0.016"x0.022"		3111-1622	3121-1622	3112-1622	3122-1622	3113-1622	3123-1622
0.017"x0.022"		3111-1722	3121-1722	3112-1722	3122-1722	3113-1722	3123-1722
0.017"x0.025"		3111-1725	3121-1725	3112-1725	3122-1725	3113-1725	3123-1725
0.018"x0.018"		3111-1818	3121-1818	3112-1818	3122-1818	3113-1818	3123-1818
0.018"x0.022"		3111-1822	3121-1822	3112-1822	3122-1822	3113-1822	3123-1822
0.018"x0.025"		3111-1825	3121-1825	3112-1825	3122-1825	3113-1825	3123-1825
0.019"x0.025"		3111-1925	3121-1925	3112-1925	3122-1925	3113-1925	3123-1925
0.021"x0.025"		3111-2125	3121-2125	3112-2125	3122-2125	3113-2125	3123-2125



NiTi Heat Activated Archwire

- Great for crowded cases where aligning and leveling will be carried out simultaneously.
- Provides light continuous force.



10/pk

	Size	Square		Ovoid		Nature	
		Upper	Lower	Upper	Lower	Upper	Lower
		Round					
0.012"		3211-0012	3221-0012	3212-0012	3222-0012	3213-0012	3223-0012
0.014"		3211-0014	3221-0014	3212-0014	3222-0014	3213-0014	3223-0014
0.016"		3211-0016	3221-0016	3212-0016	3222-0016	3213-0016	3223-0016
0.018"		3211-0018	3221-0018	3212-0018	3222-0018	3213-0018	3223-0018
0.020"		3211-0020	3221-0020	3212-0020	3222-0020	3213-0020	3223-0020
Rectangular							
0.016"x0.016"		3211-1616	3221-1616	3212-1616	3222-1616	3213-1616	3223-1616
0.016"x0.022"		3211-1622	3221-1622	3212-1622	3222-1622	3213-1622	3223-1622
0.017"x0.022"		3211-1722	3221-1722	3212-1722	3222-1722	3213-1722	3223-1722
0.017"x0.025"		3211-1725	3221-1725	3212-1725	3222-1725	3213-1725	3223-1725
0.018"x0.018"		3211-1818	3221-1818	3212-1818	3222-1818	3213-1818	3223-1818
0.018"x0.022"		3211-1822	3221-1822	3212-1822	3222-1822	3213-1822	3223-1822
0.018"x0.025"		3211-1825	3221-1825	3212-1825	3222-1825	3213-1825	3223-1825
0.019"x0.025"		3211-1925	3221-1925	3212-1925	3222-1925	3213-1925	3223-1925
0.021"x0.025"		3211-2125	3221-2125	3212-2125	3222-2125	3213-2125	3223-2125

NiTi Reverse Curve of Spee

2/pk

	Size	Square		Ovoid	
		Upper	Lower	Upper	Lower
		Round			
0.012"		3311-0012	3321-0012	3312-0012	3322-0012
0.014"		3311-0014	3321-0014	3312-0014	3322-0014
0.016"		3311-0016	3321-0016	3312-0016	3322-0016
0.018"		3311-0018	3321-0018	3312-0018	3322-0018
0.020"		3311-0020	3321-0020	3312-0020	3322-0020
Rectangular					
0.016"x0.016"		3311-1616	3321-1616	3312-1616	3322-1616
0.016"x0.022"		3311-1622	3321-1622	3312-1622	3322-1622
0.017"x0.022"		3311-1722	3321-1722	3312-1722	3322-1722
0.017"x0.025"		3311-1725	3321-1725	3312-1725	3322-1725
0.018"x0.018"		3311-1818	3321-1818	3312-1818	3322-1818
0.018"x0.022"		3311-1822	3321-1822	3312-1822	3322-1822
0.018"x0.025"		3311-1825	3321-1825	3312-1825	3322-1825
0.019"x0.025"		3311-1925	3321-1925	3312-1925	3322-1925
0.021"x0.025"		3311-2125	3321-2125	3312-2125	3322-2125

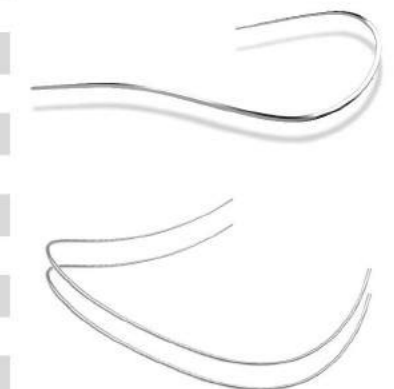



Accessories

Accessories

8.03

ACCESSORIES

Accessories

Crimpable Ball Hooks



10/pk

Specifications	Item No.
Univ (T top) 2.1mm	9121 - 021
Univ (T Top) 2.7mm	9121 - 027
Univ (T Top) 4.0mm	9121 - 040
Univ (T Top) 5.5mm	9121 - 055
Univ (T Top) 7.0mm	9121 - 070
Rectangular (T Top) 2.1mm	9121 - 221
Rectangular (T Top) 2.7mm	9121 - 227
Rectangular (T Top) 4.0mm	9121 - 240
Rectangular (T Top) 5.5mm	9121 - 255
Rectangular (T Top) 7.0mm	9121 - 270
Round (T Top) 2.1mm	9121 - 121
Round (T Top) 2.7mm	9121 - 127
Round (T Top) 4.0mm	9121 - 140
Round (T Top) 5.5mm	9121 - 155
Round (T Top) 7.0mm	9121 - 170

Specifications	Item No.
Univ (Ball Top) 2.1mm	9120 - 021
Univ (Ball Top) 2.7mm	9120 - 027
Univ (Ball Top) 4.0mm	9120 - 040
Univ (Ball Top) 5.5mm	9120 - 055
Univ (Ball Top) 7.0mm	9120 - 070
Rectangular (Ball Top) 2.1mm	9120 - 221
Rectangular (Ball Top) 2.7mm	9120 - 227
Rectangular (Ball Top) 4.0mm	9120 - 240
Rectangular (Ball Top) 5.5mm	9120 - 255
Rectangular (Ball Top) 7.0mm	9120 - 270
Round (Ball Top) 2.1mm	9120 - 121
Round (Ball Top) 2.7mm	9120 - 127
Round (Ball Top) 4.0mm	9120 - 140
Round (Ball Top) 7.0mm	9120 - 170
Round (Ball Top) 5.5mm	9120 - 155

Crimpable Archwire Hooks



10/pk

Specifications	Item No.
Universal Left 7.0mm	9122-070L
Universal Right 7.0mm	9122-070R
Round Left 7.0mm	9122-170L
Round Right 7.0mm	9122-170R
Rectangular Left 10mm	9122-210L
Rectangular Right 10mm	9122-210R
Rectangular Left 7.0mm	9122-270L
Rectangular Right 7.0mm	9122-270R

Crimpable Spiral Hooks



10/pk

Specifications	Item No.
Universal Left 10mm	9124-010L
Universal Right 10mm	9124-010R
Universal Left 8.5mm	9124-085L
Universal Right 8.5mm	9124-085R
Rectangular Left 8.5mm	9124-285L
Rectangular Right 8.5mm	9124-285R
Crimpable Hook With Button (left)	9136-216
Crimpable Hook With Button (right)	9136-217

Crimpable Stops

10/pk

Specifications	Item No.	Picture	Designation
Universal	9123 - 001		Fits round or rectangular wires
Rectangular	9123 - 201		
Round	9123 - 101		

Tongue Spikes

10/pk

Specifications	Item No.	Picture	Designation
Tongue Spikes	E9181-001		Simple way to stop tongue thrusting and thumb sucking

- Self-ligating Brackets
- Ceramic Brackets
- Lingual System
- Metal Brackets
- Buccal tubes
- Bands
- Archwires
- Accessories
- Elastomerics
- Instruments

Lingual Buttons

10/pk

Specifications	Item No.	Picture	Designation
Bondable Mesh Single 3.48mmX2.5mm	9130-202		
Weldable 4mm*2.6mm	9131-102		
Bondable F 3mm	9131-203		
Bondable 1#	9131-2A1		·Mushroom heads on a curved base that adapt themselves better to both bicuspid bands and molar bands
Bondable 2#	9131-2A2		
Bondable 3#	9131-2A3		
Bondable 4#	9131-2A4		
Bondable Mesh Wings F 3.5mm	9132-202		
Bondable Mesh Single Wings	9134-202		
Bondable , coil eyelets	9135-210		

Lingual Cleats

10/pk

Specifications	Item No.	Picture	Designation
Short Arms	9132-102		·Lingual cleats are curved to protect tissue against irritation ·One cleat accommodates up to three heavy elastics
Long Arms	9132-103		

Seating Lugs

10/pk

Specifications	Item No.	Picture	Designation
weldable	9139-101		·This lingual attachment may be welded to create your preferred band assembly.

Lingual Sheaths

10/pk

Specifications	Item No.	Picture	Designation
Without Hook or Indent	9133-104		·The horizontal style slotted tube ·The welding flanges curved slightly for a good adaptation to bands ·A wide range of availability
Without Hook with Indent	9133-105		
With Hook with Indent (Distal L)	9133-106		
With Hook with Indent (Distal R)	9133-107		
With Hook with Indent (Mesial L)	9133-108		
With Hook with Indent (Mesial R)	9133-109		
With Hook without Indent (Distal L/Mesial R)	9133-110		
With Hook without Indent (Distal R/Mesial L)	9133-111		
Bondable without Hook or Indent	9133-204		

Lingual Retainers (Bondable)

10/pk

Specifications	Item No.	Picture	Designation
Maxillary 38	9141 - U38		·Allow for long term stability with physiologic teeth movement ·Tight mesh base twist facilitates bonding without end loops or bonding pads ·Bond any or all teeth in segment
Maxillary 40	9141 - U40		
Maxillary 42	9141 - U42		
Maxillary 45	9141 - U45		
Maxillary 47	9141 - U47		
Mandibular 29	9141 - L29		
Mandibular 31	9141 - L31		
Mandibular 33	9141 - L33		
Mandibular 35	9141 - L35		
Mandibular 37	9141 - L37		



NiTi Closed Springs

10/pk

Specifications	Item No.	Picture	Specifications	Item No.	Picture		
Light Force 0.008 9mm	9101-109		Light Force 0.008 9mm	9103-109			
Light Force 0.008 10mm	9101-110		Light Force 0.008 10mm	9103-110			
Light Force 0.008 12mm	9101-112		Light Force 0.008 12mm	9103-112			
Light Force 0.008 14mm	9101-114		Light Force 0.008 14mm	9103-114			
Light Force 0.008 16mm	9101-116		Light Force 0.008 16mm	9103-116			
Medium Force 0.01 9mm	9101-209		Medium Force 0.01 9mm	9103-209			
Medium Force 0.01 10mm	9101-210		Medium Force 0.01 10mm	9103-210			
Medium Force 0.01 12mm	9101-212		Medium Force 0.01 12mm	9103-212			
Medium Force 0.01 14mm	9101-214		Medium Force 0.01 14mm	9103-214			
Medium Force 0.01 16mm	9101-216		Medium Force 0.01 16mm	9103-216			
Light Force 0.008 9mm	9102-109			Light Force 0.008 9mm		9104-109	
Light Force 0.008 10mm	9102-110			Light Force 0.008 10mm		9104-110	
Light Force 0.008 12mm	9102-112	Light Force 0.008 12mm		9104-112			
Light Force 0.008 14mm	9102-114	Light Force 0.008 14mm		9104-114			
Light Force 0.008 16mm	9102-116	Light Force 0.008 16mm		9104-116			
Medium Force 0.01 9mm	9102-209	Medium Force 0.01 6mm		9104-206			
Medium Force 0.01 10mm	9102-210	Medium Force 0.01 9mm		9104-209			
Medium Force 0.01 12mm	9102-212	Medium Force 0.01 10mm		9104-210			
Medium Force 0.01 14mm	9102-214	Medium Force 0.01 12mm		9104-212			
Medium Force 0.01 16mm	9102-216	Medium Force 0.01 14mm		9104-214			
		Medium Force 0.01 16mm		9104-216			

NiTi Open Coil Springs

2/pkg

Specifications	Item No.	Picture	Designation
0.010mm	9100-010		Open and maintain space sently and efficiently in a convenient cut to length design
0.012mm	9100-012		

Uprighting Springs

10/pk

Specifications	Item No.	Picture	Designation
Clockw ise	9106-103		·Used to upright individual tooth mesiodistally.
CCW	9106-203		

Rotating Springs

10/pk

Specifications	Item No.	Picture	Designation
Clockw ise	9107-103		· Introduced into pin channel on light wire brackets , after uprighting springs and torquing auxiliaries are removed · Useful w ith tight tooth contact
CCW	9107-203		

Self-Locking Separating Springs

10/pk

Specifications	Item No.	Picture	Designation
0.5mm/0.020"	9105-005		· For separating the teeth to place the bands

Single-Looped Archwires

10/pk

Specifications	Item No.	Picture	Designation
0.017×0.025 Small	9108-103		· Torque control for anterior teeth
0.018×0.025 Small	9108-113		
0.019×0.025 Small	9108-123		
0.017×0.025 Medium	9108-203		
0.018×0.025 Medium	9108-213		
0.019×0.025 Medium	9108-223		
0.017×0.025 Large	9108-303		
0.018×0.025 Large	9108-313		
0.019×0.025 Large	9108-323		
0.016×0.022 Small	9108-A03		
0.016×0.022 Medium	9108-B03		
0.016×0.022 Large	9108-C03		

Five-Looped Archwires

10/pk

Specifications	Item No.	Picture	Designation
Small	9109-104		<ul style="list-style-type: none"> Used in BEGG treatment for more anchorage to help posterior teeth move faster
Medium	9109-204		
Large	9109-304		

Expansion Screws

10/pk

Specifications	Item No.	Picture	Designation
Mni	9161-001		<ul style="list-style-type: none"> Indications: -Cleft palate -Maxillary arch discrepancies Most have double guide pins for linear movement Single guide pin narrow body configuration available for partial quadrant and expansions Includes adjustment key with each assembly 1/4 turn for expansion 0.2mm
Base	9161-002		
Stent	9162-201		
Stent A	9162-202		

Crimpable Gate Spring

5/pk

Specifications	Item No.	Picture	Designation
Crimpable Gate Spring	9108-445-06		<ul style="list-style-type: none"> Torque control for anterior teeth
Crimpable Gate Spring	9108-445-08		

J Hooks

2/pk

Specifications	Item No.	Picture	Designation
Heavy Force I	9031 - 285		<ul style="list-style-type: none"> A part of extaloral appliance For pulling anterior teeth in and backwards and helping posterior teeth move distally
Heavy Force II	9032 - 285		
Light Force II	9032 - 165		
Light Force Extra long II	9032 - 178		

Palatal Arch Bars

10/pk

Specifications	Item No.	Picture	Designation
Distal 37#	9151-137		<ul style="list-style-type: none"> Stainless steel palatal bar is designed to fit .036 lingual sheath and provide control of upper first molars
Distal 39#	9151-139		
Distal 41#	9151-141		
Distal 43#	9151-143		
Distal 45#	9151-145		
Distal 47#	9151-147		
Distal 49#	9151-149		
Distal 51#	9151-151		
Distal 53#	9151-153		
Distal 55#	9151-155		
Mesial 37#	9152-137		
Mesial 39#	9152-139		
Mesial 41#	9152-141		
Mesial 43#	9152-143		
Mesial 45#	9152-145		
Mesial 47#	9152-147		
Mesial 49#	9152-149		
Mesial 51#	9152-151		
Mesial 53#	9152-153		
Mesial 55#	9152-155		

Face Bows

1/pk

Specifications	Item No.	Picture	Designation
Universal	9020 - 001		<ul style="list-style-type: none"> Universal inner bow diameter is .045 Two friction stops at each end of the inner bow Outer bow non-angulated
Asymmetry Face Bow s 1#	9021 - 083		<ul style="list-style-type: none"> Inner bow with cuspid hooks Outer bow non-angulated Inner bow diameter is with variations to different needs
Asymmetry Face Bow s 2#	9021 - 090		
Asymmetry Face Bow s 3#	9021 - 097		
Asymmetry Face Bow s 4#	9021 - 104		
Asymmetry Face Bow s 5#	9021 - 111		



Adjustable Headgears

1/pk

Specifications	Item No.	Picture	Designation
Universal	9004 - 001		<ul style="list-style-type: none"> ·The kit is used for pulling chin backwards. ·It contains head cap, chin cup, rivets, elastics and bags.
Small	9004 - 102		
Medium	9004 - 202		
Large	9004 - 302		
Universal (With Chin Cups)	9005 - 001		
Small (With Chin Cups)	9005 - 102		
Medium (With Chin Cups)	9005 - 202		
Large (With Chin Cups)	9005 - 302		

Headgears with J-Hook

1/pk

Specifications	Item No.	Picture	Designation
Small (with J Hook 9032-165)	9001 - 102		<ul style="list-style-type: none"> ·Headcap and J-Hook pre-assembled for your convenience ·J-Hooks easily adaptable for fit and comfort ·Available in three force levels
Small (with J Hook 9032-178)	9001 - 103		
Medium (with J Hook 9032-165)	9001 - 202		
Medium (with J Hook 9032-178)	9001 - 203		
Large (with J Hook 9032-165)	9001 - 302		
Large (with J Hook 9032-178)	9001 - 303		
Extra Large (with J Hook 9032-165)	9001 - 402		
Extra Large (with J Hook 9032-178)	9001 - 403		

High-Pull Headgears

1/pk

Specifications	Item No.	Picture	Designation
Small	9000-101		<ul style="list-style-type: none"> ·Headcap is 100% cotton and washable ·The safety-release modules can be separated automatically when pulled by an excessive force, so as to reduce the risk of injury caused by face bow
Medium	9000-201		
Large	9000-301		
Extra large	9000-401		



Mandibular Pull Headcaps

1/pk

Specifications	Item No.	Picture	Designation
Small	9002 - 101		<ul style="list-style-type: none"> ·Designed to prevent and treat malocclusion ·Quickly and easily fit to the individual patient ·Replacement taps available separately
Medium	9002 - 201		
Large	9002 - 301		
Extra Large	9002 - 401		



Safety Neck Pads

1/pk





Specifications	Item No.	Picture	Designation
Universal Standard	9003-001		<ul style="list-style-type: none"> ·Prescription tab force gauges provide adjustable force ·Comfortable cloth-cornered foam pad is easily removed for washing ·Gauges sold separately
Universal Extra Length	9003-002		
Universal Standard	9003-011		
Universal Extra Length	9003-012		
Safety Release Module	9003-021		

- Self-igniting Brackets
- Ceramic Brackets
- Lingual System
- Metal Brackets
- Buccal tubes
- Bands
- Archwires
- Accessories
- Elastomerics
- Instruments

Chin Cups 1/pk

Specifications	Item No.	Picture	Designation
Univerdal I	9041-001		<ul style="list-style-type: none"> Made of markolon of food grade quality or other ABS material The hook at two sides can bear to 10F force
Univerdal II	9042-001		
Leather	9043-001		

Face Masks 1/pk

Specifications	Item No.	Picture	Designation
Adjustable	9011 - 001		<ul style="list-style-type: none"> Maximum patient comfort Treats maxillary insufficiencies Fully adjustable Stainless steel and plastic Leather padded contact points Hexagon key included
Fixed	9012 - 201		
Bi-Shaft	9013 - 001		
Multi-Adjustable (red)	9014 - 001		
Adjustable (shaft blue)	9014 - 002		

Stainless Steel Reflectors (Mirrors) 1/pk

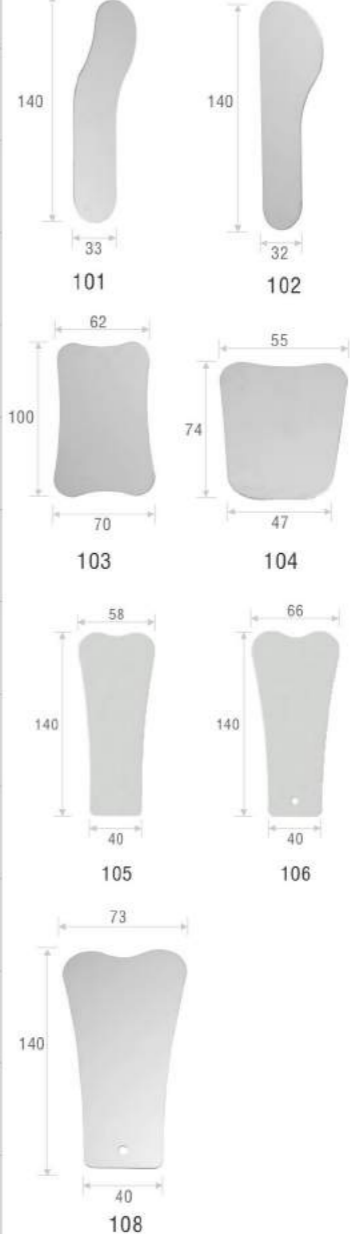
Specifications	Item No.	Picture	Designation
Stainless Steel Mirror 101	7201-101		<ul style="list-style-type: none"> The Surface is coated with nickel chromium on a copper base to provide clear reflected images with natural color The alloy hardened base will not shatter, chip or break if dropped Anti-scratch
Stainless Steel Mirror 102	7201-102		
Stainless Steel Mirror 103	7201-103		
Stainless Steel Mirror 104	7201-104		
Stainless Steel Mirror 105	7201-105		
Stainless Steel Mirror 106	7201-106		
Stainless Steel Mirror 108	7201-108		
Duplex With Hard Surface 101	7212-101		
Duplex With Hard Surface 102	7212-102		
Duplex With Hard Surface 103	7212-103		
Duplex With Hard Surface 104	7212-104		
Duplex With Hard Surface 105	7212-105		
Duplex With Hard Surface 106	7212-106		
Duplex With Hard Surface 108	7212-108		

- Self-ligating Brackets
- Ceramic Brackets
- Lingual System
- Metal Brackets
- Buccal Tubes
- Bands
- Archwires
- Accessories
- Elastomers
- Instruments

Lip Retractors

10/pk









Specifications	Item No.	Picture	Designation
Small	7101-101		<ul style="list-style-type: none"> ·Made of clear plastic of food grade material for bonding and photo purpose ·Compatible with cold sterilization and the autoclave < 120°
Middle	7101-201		
Large	7101-301		
Double Ended	7131-201		

Photo Cheek Retractors

10/pk

Specifications	Item No.	Picture	Designation
Children	7112-100		<ul style="list-style-type: none"> ·Made of clear plastic of food grade material for photo purpose ·Compatible with cold sterilization and the autoclave < 120°
Adult	7112-200		
Lateral	7122-001		
Lip	7123-001		

Arch Turrets

1/pk

Specifications	Item No.	Picture	Designation
General Alloy (Aluminum Handle)	7401-100		<ul style="list-style-type: none"> ·0° ·Automatic arch former with precision ·For wires from .016, .017, .018, .019, .022.
All-Steel High-Precision	7402-200		

Brackets Tray

1/pk

Specifications	Item No.	Picture	Designation
single draw	7010-100	<p>285mm*210mm*35mm Weight:470g</p> 	<ul style="list-style-type: none"> ·Beige plastic with white insert ·For stocking brackets ·Plastic boxes can be locked together for easy stacking

Bands Tray

1/pk

Specifications	Item No.	Picture	Designation
4 Draw s for 1st molar bands	7000-100	<p>285mm*210mm*140mm Weight:1880g</p> 	<ul style="list-style-type: none"> ·Beige plastic with white insert ·For direct bonds or bands ·Plastic boxes can be locked together for easy stacking
4 Draw s for 2nd molar bands	7000-200		

Typodonts

1/pk

Specifications	Item No.	Picture	Designation
Transparent , Slanting plate , Standard maxillofacial surface	7741-403		<ul style="list-style-type: none"> ·Typodonts are available for instructional purposes as shown.
Red , Flat plate , Standard maxillofacial surface , (with shinye logo)	7741-406		

- Self-ligating Brackets
- Ceramic Brackets
- Lingual System
- Metal Brackets
- Buccal tubes
- Bands
- Archwires
- Accessories
- Elastomerics
- Instruments



Elastomerics

Ligature Ties	9.03
Intraoral Elastics	9.04
Elastomeric Chain	9.04
Elastomeric Separator	9.04

ELASTOMERICS

Elastomerics

Ligature Ties

- Available in bags of 36 sticks, 26 ligatures per stick.

Item No.	Specifications	Colors	Item No.	Specifications	Colors
9191-1100	Mixed		9191-1118	18#	Transparent Red
9191-1101	1#	Clear	9191-1119	19#	Light Purple
9191-1102	2#	Silver	9191-1120	20#	Light Pink
9191-1103	3#	White	9191-1121	21#	Nacarat
9191-1104	4#	Red	9191-1122	22#	Peach Red
9191-1105	5#	Pink	9191-1123	23#	Light Blue
9191-1106	6#	Golden	9191-1124	24#	Light Blue
9191-1107	7#	Orange	9191-1125	25#	Metal Light Blue
9191-1108	8#	Grey	9191-1126	26#	Dark Blue
9191-1109	9#	Black	9191-1127	27#	Light Yellow
9191-1110	10#	Green	9191-1128	28#	Light Purple
9191-1111	11#	Yellow	9191-1129	29#	Burgundy
9191-1112	12#	Purple	9191-1130	30#	Red Orange
9191-1113	13#	Blue	9191-1131	31#	Transparent Purple
9191-1114	14#	Light Green	9191-1132	32#	Metal Purple
9191-1115	15#	Sky Blue	9191-1133	33#	Metal Dark Purple
9191-1116	16#	Indigo	9191-1134	34#	Metal Light Green
9191-1117	17#	Cyan	9191-1135	35#	Metal Green

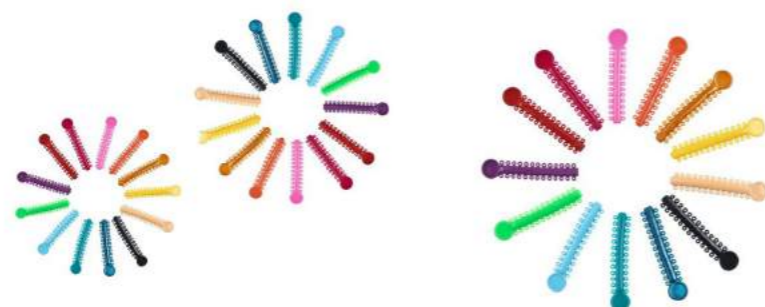

Intraoral Elastics

- Available in bags of 50 packs, 100 pcs in per pack.

Item No.	Specifications	Item No.	Specifications
9194-1351	1/4" (3.5OZ)	9194-1451	1/4" (4.5OZ)
9194-1352	1/8" (3.5OZ)	9194-1452	1/8" (4.5OZ)
9194-1353	3/8" (3.5OZ)	9194-1453	3/8"(4.5OZ)
9194-1354	3/16" (3.5OZ)	9194-1454	3/16" (4.5OZ)
9194-1355	5/16" (3.5OZ)	9194-1455	5/16" (4.5OZ)



Elastomeric Chain

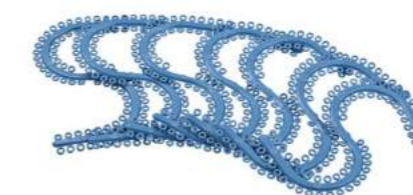

Elastomeric Separator

Instruments

Beyond Series 10.03

Flex Series 10.07

INSTRUMENTS



Instruments

BEYOND Series

- High quality polished surgical steel handles
- Orbit formed joint secures the joint from becoming loose
- Plier and cutter beaks rounded for safety and lip comfort
- Diamond-honed, nickel brazed cutting blades
- Inserted lip of fine alloy steel



Ligature Cutter

4B19

The plier is used to cut ligature wire and rubber band with diameter below 0.3mm.



Ligature Cutter 45°

4B19-8

The plier is used to cut ligature wire and rubber band with diameter below 0.3mm.



Distal End Cutter , Long handle

4B21-2

The plier is used to cut distal of overlong arch wires and can reliable clip the arch wire that was cut down.



Light Wire Plier

4B20

Used to bending arch wires with different specifications and fine loops with different radians as well as various reed loops.



Light Wire Plier with Cutter

4B20-12

Used to bending arch wires with different specifications and fine loops with different radians as well as various reed loops and the middle part of the jaw is used for cutting.



Hard Wire Cutter

4B19-14

Used to cut various Australian wires ,niti wires and stainless steel wires with diameter less than 0.030"/0.76mm.



Three Jaw Plier

4A39

Used to bend V loop and mould various arch wires. arch wires to be bent can be 0.030"/0.76mm.

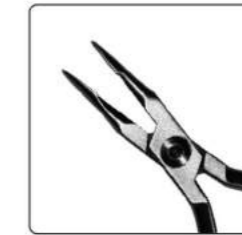

Pliers utility Weingart silm

4A06-D

With lengthen beak, more easy to reach far and tougne place.



Adhesive Remover Plier

4A07

The distal end cuts and clips the arch wire, in parallel with arch wire hole at the far end of the buccal tube.



Band Remover

4A08-E

Used to remove the posterior band in the back root area as well as the bracket attachments adhering directly to teeth.



Torque Plier

4A09

Used to bend into square wire torque and shall be used in pair. the blade width is 0.050"/1.27mm.



Torque Plier

4A09-16

To make arch bending wire. Used in pairs.



Loop Bending Plier

4A10

Used to bend various diameter-fixed small circular loops of the multi-loop edgewise wire arch, bending diameter is :2mm, 3.2mm and 4.2mm.



Kim Plier

4A11

Used to bend multi-loop edgewise wire arch and the middle part of the jaw is with cutting function.

- Self-ligating Brackets
- Ceramic Brackets
- Lingual System
- Metal Brackets
- Buccal tubes
- Bands
- Archwires
- Accessories
- Elastomers
- Instruments



NiTi Distal Cinch Back Pliers
4A13
Used to bend distal end of orthodontic arch to avoid damages of oral soft tissue from the arch wire ends.



Ω Plier
4A24
To make Ω loop.



Distal End Bending Pliers
4B27
Used for bending small loops of arch wire, stop loops of distal end, etc. Max: 0.022"/0.50mm.



Nance Loop Bending Plier
4A25
Used to bend nance loops of 3,4,5 and 6mm of different height in the orthodontic arch wires and the arch can amount 0.020"/0.56mm.



How's Plier
4A18
Used to clip and insert the arch wire into buccal tubes and to clip ligature wire or used to form the posterior band of the front teeth.



Pliers Arch Forming Hollow Chop
4A26
Made for accurate bending for pliers.



Jarabak Light Wire Plier
4A20-9
Groove type plier, used for accurately bending arch wire and dose loop.



Torque Plier With Key
4A30



Crimpable Hooks Plier
4A02
Used to clip and lock the dissociative towing hook.



Bracket Remover
4A05-10
Used to remove various brackets of front teeth.



Cap Remover Plier
4A03
Used to remove the cap covering the buccal tube.



Posterior Brackets Remover
4A05-11
Used to remove various brackets of posterior root.



Elastic Plier
4A04
Used for placement of elastic separators.



Weingart Pliers
4A06-A
Design of end sawtooth. To steady orthodontic wire and cinch back.



Tweed Plier
4B14
Used for bending small loops of arch wire, stop loops of distal end, etc. Max: 0.022"/0.50mm.



V Bending Pliers
4B35
Make V-shaped stop loop on the arch wire, including Niti arch wire, to prevent displacement of arch wires.



Universal Plier
4A16
Used for bending, leveling, and cutting.



Detailing Step Pliers
4B33
Made for no trip wire, suitable for make wire.



Plier Shelf
7611

- Self-ligating Brackets
- Ceramic Brackets
- Lingual System
- Metal Brackets
- Buccal tubes
- Bands
- Archwires
- Accessories
- Elastomers
- Instruments



FLEX Series

- The pliers body is made of imported medical stainless steel, which makes the product with high hardness, not easy to fall off, good performance in corrosion resistance and no discoloration.
- Ergonomic and edge arc design allows doctors to achieve a more comfortable feel and patients with greater safety assurance.
- The use of advanced equipment for production and processing, ensured consistency and stability of products.
- The cutting pliers head uses laser cladding technology which can cut 60 thousand times at a single point. The cutter head is not easy to fall off, to rust and to tarnish.



Ligature Cutter
 4J19-100 0° ,Mini 4J19-113 13° ,Mini
 4J19-300 0° 4J19-313 13°
 4J19-330 30° 4J19-345 45°
 4J19-400 0° ,Long handle 4J19-413 13° ,Long handle

The plier is used to cut ligature wire and rubber band with diameter below 0.3mm.

Distal End Cutter
 4J21-100 4J21-200,Long handle
 4J21-300 4J21-400,Long handle

The plier is used to cut distal of overlong arch wires and can reliable clip the arch wire that was cut down.

Light Wire Plier
 4J20-301
 4J20-401,Long handle

Used to bending arch wires with different specifications and fine loops with different radians as well as various reed loops.

Band Remover , Short Jaw
 4J08-300

Used to remove the posterior band in the back root area as well as the bracket attachments adhering directly to teeth.

Torque Plier With Key
 4J09-301

Used to bend into square wire torque and shall be used in pair. the blade width is 0.050"/1.27mm.

Bracket Remover
 4J05-301

Used to remove various brackets of front teeth.

Tweed Loop Bending Plier
 4J22-300

To make Ω loop.

Hard Wire Cutter
 4J34-300

Used to cut various Australian wires ,niti wires and stainless steel wires with diameter less than 0.030"/0.76mm.

Flush Distal End Cutter
 4J28-200 ,Mini Long handle
 4J28-400,Long handle 4J28-300

The plier is used to cut distal end and can reliably clips the arch wire that was cut down ,make the arch wire in parallel with the arch wire hole at the far end of the buccal tube.

Light Wire Plier with Cutter
 4J20-302
 4J20-402,Long handle

Used to bending arch wires with different specifications and fine loops with different radians as well as various reed loops and the middle part of the jaw is used for cutting.

Band Remover, Long Jaw
 4J08-400

Used to remove the posterior band in the back root area as well as the bracket attachments adhering directly to teeth.

Torque Plier
 4J09-300

Used to bend into square wire torque and shall be used in pair. the blade width is 0.050"/1.27mm.

Loop Bending Plier
 4J10-300

Used to bend various diameter-fixed small circular loops of the multi-loop edgewise wire arch, bending diameter is :2mm, 3.2mm and 4.2mm.

Posterior Brackets Remover
 4J05-302
 4J05-400 Long handle

Used to remove various brackets of posterior root.



Three Jaw Plier
4J12-300
Used to bend V loop and mould various arch wires. arch wires to be bent can be 0.030"/0.76mm.



Crimpable Hooks Plier
4J02-301
Used to clip and lock the dissociative towing hook.



V Bending Plier
4J35-300
Make V-shaped stop loop on the arch wire, including Niti arch wire, to prevent displacement of arch wires.



Ceramic Bracket Remover 45°
4J48-301
The plier is used to remove various ceramic brackets of front teeth.



Weingart Plier
4J13-300
4J13-400, Long handle
Used to bend distal end of orthodontic arch to avoid damages of oral soft tissue from the arch wire ends.



Cap Remover Plier
4J03-300
4J03-3F1, replacement
Used to remove the cap covering the buccal tube.



NiTi Distal Cinch Back Pliers
4J41-300
4J41-400, Long handle
Used to bend distal end of the Niti orthodontic arch wires, thus the damage of oral soft tissue from the arch wire end can be avoid.



Ω Plier
4J24-300
To make Ω loop.



Tweed Plier
4J14-300
Used for bending small loops of arch wire, stop loops of distal end, etc. Max: 0.022"/0.50mm.



Band Remover, Plastic
4J08-301
Used to remove the posterior band in the back root area as well as the bracket attachments adhering directly to teeth.



Elastic Plier
4J04-300
Used for placement of elastic separators.



Plier Shelf
7613 7614 Extra Length
7615 7616 Extra Length
Used to bend distal end of the Niti orthodontic arch wires, thus the damage of oral soft tissue from the arch wire end can be avoid.



Adhesive Remover Plier, Plastic tip
4J07-301
The distal end cuts and clips the arch wire, in parallel with arch wire hole at the far end of the buccal tube.



Adhesive Remover Plier
4J07-300
The distal end cuts and clips the arch wire, in parallel with arch wire hole at the far end of the buccal tube.

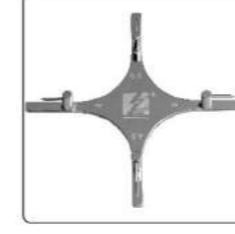

Bracket Gauge
7310-100
·Measures 3.4mm, 4.0mm, 4.5mm and 5.0mm



Bracket Gauge
7311
·Measures 3.4mm, 4.0mm, 4.5mm and 5.0mm



Universal Plier
4J16-300
Used for bending, leveling, and cutting.



Jarabak Light Wire Plier
4J20-303
Groove type plier, used for accurately bending arch wire and dose loop.



Beak Plier
4J17-300
Groove type plier, the plier adopt nano technology and for accurate bending arch wire and closed loop.



Kim Plier
4J11-300
Used to bend multi-loop edgewise wire arch and the middle part of the jaw is with cutting function.



How's Plier
4J18-300
Used to clip and insert the arch wire into buccal tubes and to clip ligature wire or used to from the posterior band of the front teeth.



Nance Loop Bending Plier
4J25-300
Used to bend nance loops of 3, 4, 5 and 6mm of different height in the orthodontic arch wires and the arch can amount 0.020"/0.56mm.

Self-ligating Brackets
Ceramic Brackets
Lingual System
Metal Brackets
Buccal tubes
Bands
Archwires
Accessories
Elastomers
Instruments